



High Quality, 10-Bit, Digital CCIR-601 to PAL/NTSC Video Encoder

ADV7175A/ADV7176A*

FEATURES

- ITU-R BT601/656 YCrCb to PAL/NTSC Video Encoder
- High Quality 10-Bit Video DACs
- Integral Nonlinearity <1 LSB at 10 Bits
- NTSC-M, PAL-M/N, PAL-B/D/G/H/I
- Single 27 MHz Clock Required (x2 Oversampling)
- 80 dB Video SNR
- 32-Bit Direct Digital Synthesizer for Color Subcarrier
- Multistandard Video Output Support:
 - Composite (CVBS)
 - Component S-Video (Y/C)
 - Component YUV and RGB
 - EuroSCART Output (RGB + CVBS/LUMA)
- Video Input Data Port Supports:
 - CCIR-656 4:2:2 8-Bit Parallel Input Format
 - 4:2:2 16-Bit Parallel Input Format
- SMPTE 170M NTSC Compatible Composite Video
- ITU-R BT.470 PAL Compatible Composite Video
- Full Video Output Drive or Low Signal Drive Capability
 - 34.7 mA max into 37.5 Ω (Doubly-Terminated 75R)
 - 5 mA min with External Buffers
- Programmable Simultaneous Composite and S-Video Y/C or RGB (SCART)/YUV Video Outputs
- Programmable Luma Filters (Low-Pass/Notch/Extended)
- Programmable VBI (Vertical Blanking Interval)
- Programmable Subcarrier Frequency and Phase

- Programmable LUMA Delay
- Individual ON/OFF Control of Each DAC
- CCIR and Square Pixel Operation
- Integrated Subcarrier Locking to External Video Source
- Color Signal Control/Burst Signal Control
- Interlaced/Noninterlaced Operation
- Complete On-Chip Video Timing Generator
- Programmable Multimode Master/Slave Operation
- Macrovision Antitaping Rev 7.01 (ADV7175A Only)**
- Closed Captioning Support
- Teletext Insertion Port (PAL-WST)
- Onboard Color Bar Generation
- Onboard Voltage Reference
- 2-Wire Serial MPU Interface (I²C Compatible)
- Single Supply +5 V or +3 V Operation
- Small 44-Lead PQFP Thermally Enhanced Package

APPLICATIONS

- MPEG-1 and MPEG-2 Video, DVD, Digital Satellite/Cable Systems (Set Top Boxes/IRDs), Digital TVs, CD Video/Karaoke, Video Games, PC Video/Multimedia

GENERAL DESCRIPTION

The ADV7175A/ADV7176A is an integrated digital video encoder that converts Digital CCIR-601 4:2:2 8 or 16-bit component video data into a standard analog baseband television

(Continued on page 11)

FUNCTIONAL BLOCK DIAGRAM

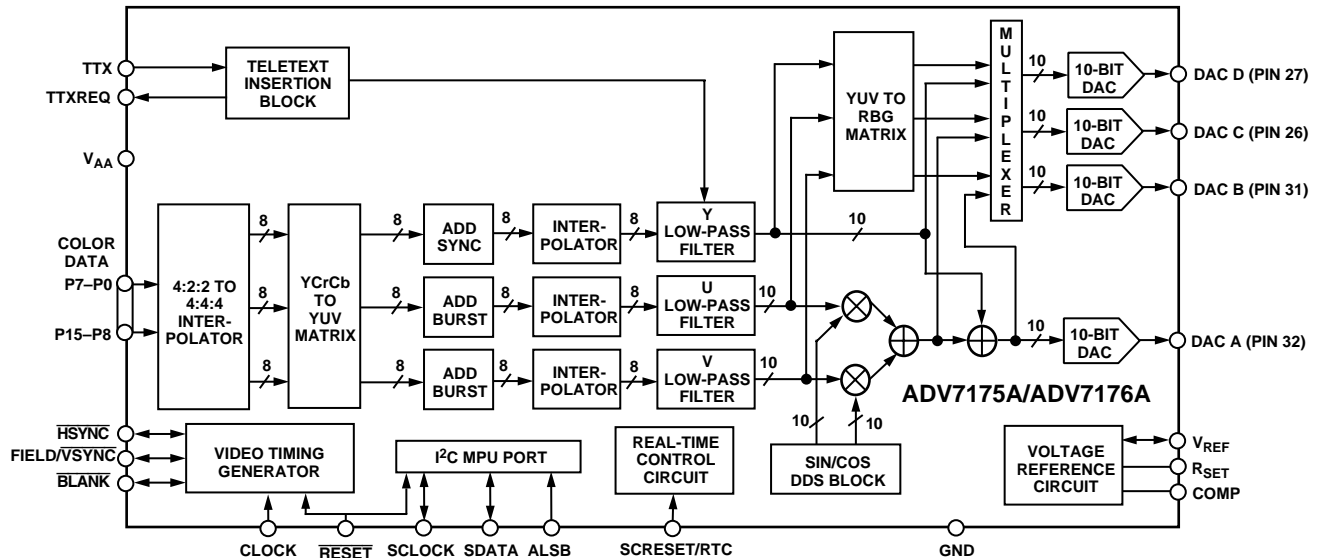

*Protected by U.S. patents numbers 5,343,196 and 5,442,355 and other intellectual property rights.

**This device is protected by U.S. Patent Numbers 4631603, 4577216, 4819098 and other intellectual property rights. The Macrovision anticopy process is licensed for noncommercial home use only, which is its sole intended use in the device. Please contact sales office for latest Macrovision version available. NOTE: ITU-R and CCIR are used interchangeably in this document (ITU-R has replaced CCIR recommendations).

REV. B

Information furnished by Analog Devices is believed to be accurate and reliable. However, no responsibility is assumed by Analog Devices for its use, nor for any infringements of patents or other rights of third parties which may result from its use. No license is granted by implication or otherwise under any patent or patent rights of Analog Devices.

One Technology Way, P.O. Box 9106, Norwood, MA 02062-9106, U.S.A.
 Tel: 781/329-4700 World Wide Web Site: <http://www.analog.com>
 Fax: 781/326-8703 © Analog Devices, Inc., 1998

ADV7175A/ADV7176A—SPECIFICATIONS

5 V SPECIFICATIONS ($V_{AA} = +5\text{ V} \pm 5\%$ ¹, $V_{REF} = 1.235\text{ V}$ $R_{SET} = 150\ \Omega$. All specifications T_{MIN} to T_{MAX} ² unless otherwise noted)

| Parameter | Conditions ¹ | Min | Typ | Max | Units |
|---------------------------------------|--|-------|-------|----------|---------------|
| STATIC PERFORMANCE | | | | | |
| Resolution (Each DAC) | | | | 10 | Bits |
| Accuracy (Each DAC) | | | | ± 1 | LSB |
| Integral Nonlinearity | | | | ± 1 | LSB |
| Differential Nonlinearity | Guaranteed Monotonic | | | ± 1 | LSB |
| DIGITAL INPUTS | | | | | |
| Input High Voltage, V_{INH} | | 2 | | | V |
| Input Low Voltage, V_{INL} | | | | 0.8 | V |
| Input Current, I_{IN} ³ | $V_{IN} = 0.4\text{ V or } 2.4\text{ V}$ | | | ± 1 | μA |
| Input Current, I_{IN} ⁴ | $V_{IN} = 0.4\text{ V or } 2.4\text{ V}$ | | | ± 50 | μA |
| Input Capacitance, C_{IN} | | | 10 | | pF |
| DIGITAL OUTPUTS | | | | | |
| Output High Voltage, V_{OH} | $I_{SOURCE} = 400\ \mu\text{A}$ | 2.4 | | | V |
| Output Low Voltage, V_{OL} | $I_{SINK} = 3.2\text{ mA}$ | | | 0.4 | V |
| Three-State Leakage Current | | | | 10 | μA |
| Three-State Output Capacitance | | | 10 | | pF |
| ANALOG OUTPUTS | | | | | |
| Output Current ⁵ | | 33 | 34.7 | 37 | mA |
| Output Current ⁶ | | | 5 | | mA |
| DAC-to-DAC Matching | | | 0.6 | 5 | % |
| Output Compliance, V_{OC} | | 0 | | +1.4 | V |
| Output Impedance, R_{OUT} | | | 15 | | k Ω |
| Output Capacitance, C_{OUT} | $I_{OUT} = 0\text{ mA}$ | | | 30 | pF |
| VOLTAGE REFERENCE | | | | | |
| Reference Range, V_{REF} | $I_{VREFOUT} = 20\ \mu\text{A}$ | 1.112 | 1.235 | 1.359 | V |
| POWER REQUIREMENTS⁷ | | | | | |
| V_{AA} | | 4.75 | 5.0 | 5.25 | V |
| Normal Power Mode | | | | | |
| $I_{DAC}(\text{max})$ ⁸ | | | 150 | 155 | mA |
| $I_{DAC}(\text{min})$ ⁸ | | | 20 | | mA |
| I_{CCT} ⁹ | | | 100 | 150 | mA |
| Low Power Mode | | | | | |
| $I_{DAC}(\text{max})$ ⁸ | | | 80 | | mA |
| $I_{DAC}(\text{min})$ ⁸ | | | 15 | | mA |
| I_{CCT} ⁹ | | | 100 | 150 | mA |
| Power Supply Rejection Ratio | COMP = 0.1 μF | | 0.01 | 0.5 | %/% |

NOTES

¹The max/min specifications are guaranteed over this range. The max/min values are typical over 4.75 V to 5.25 V.

²Temperature range T_{MIN} to T_{MAX} : 0°C to 70°C.

³All digital input pins except pins $\overline{\text{RESET}}$ and $\overline{\text{RTC/SCRESET}}$.

⁴Excluding all digital input pins except pins $\overline{\text{RESET}}$ and $\overline{\text{RTC/SCRESET}}$.

⁵Full drive into 37.5 Ω load.

⁶Minimum drive current (used with buffered/scaled output load).

⁷Power measurements are taken with Clock Frequency = 27 MHz. Max $T_J = 110^\circ\text{C}$.

⁸ I_{DAC} is the total current (min corresponds to 5 mA output per DAC, max corresponds to 37 mA output per DAC) to drive all four DACs. Turning off individual DACs reduces I_{DAC} correspondingly.

⁹ I_{CCT} (Circuit Current) is the continuous current required to drive the device.

Specifications subject to change without notice.

3.3 V SPECIFICATIONS ($V_{AA} = +3.0\text{ V} - 3.6\text{ V}^1$, $V_{REF} = 1.235\text{ V}$ $R_{SET} = 300\ \Omega$. All specifications T_{MIN} to T_{MAX}^2 unless otherwise noted)

| Parameter | Conditions ¹ | Min | Typ | Max | Units |
|---|---|------|-------|----------|---------------|
| STATIC PERFORMANCE³ | | | | | |
| Resolution (Each DAC) | | | | 10 | Bits |
| Accuracy (Each DAC) | | | | ± 1 | LSB |
| Integral Nonlinearity | | | | ± 1 | LSB |
| Differential Nonlinearity | Guaranteed Monotonic | | | ± 1 | LSB |
| DIGITAL INPUTS | | | | | |
| Input High Voltage, V_{INH} | | | 2 | | V |
| Input Low Voltage, V_{INL} | | | 0.8 | | V |
| Input Current, $I_{IN}^{3, 4}$ | $V_{IN} = 0.4\text{ V or }2.4\text{ V}$ | | | ± 1 | μA |
| Input Current, $I_{IN}^{3, 5}$ | $V_{IN} = 0.4\text{ V or }2.4\text{ V}$ | | | ± 50 | μA |
| Input Capacitance, C_{IN} | | | 10 | | pF |
| DIGITAL OUTPUTS | | | | | |
| Output High Voltage, V_{OH} | $I_{SOURCE} = 400\ \mu\text{A}$ | | 2.4 | | V |
| Output Low Voltage, V_{OL} | $I_{SINK} = 3.2\text{ mA}$ | | 0.4 | | V |
| Three-State Leakage Current ³ | | | | 10 | μA |
| Three-State Output Capacitance ³ | | | 10 | | pF |
| ANALOG OUTPUTS³ | | | | | |
| Output Current ^{6, 7} | | 16.5 | 17.35 | 18.5 | mA |
| Output Current ⁸ | | | 5 | | mA |
| DAC-to-DAC Matching | | | 2.0 | | % |
| Output Compliance, V_{OC} | | 0 | | +1.4 | V |
| Output Impedance, R_{OUT} | | | 15 | | k Ω |
| Output Capacitance, C_{OUT} | | | | 30 | pF |
| POWER REQUIREMENTS^{3, 9} | | | | | |
| V_{AA} | | 3.0 | 3.3 | 3.6 | V |
| Normal Power Mode | | | | | |
| $I_{DAC}(\text{max})^{10}$ | | | 150 | 155 | mA |
| $I_{DAC}(\text{min})^{10}$ | | | 20 | | mA |
| I_{CCT}^9 | | | 45 | | mA |
| Low Power Mode | | | | | |
| $I_{DAC}(\text{max})^{10}$ | | | 75 | | mA |
| $I_{DAC}(\text{min})^{10}$ | | | 15 | | mA |
| I_{CCT}^{11} | | | 45 | | mA |
| Power Supply Rejection Ratio | COMP = 0.1 μF | | 0.01 | 0.5 | %/% |

NOTES

- ¹The max/min specifications are guaranteed over this range. The max/min values are typical over 3.0 V to 3.6 V.
- ²Temperature range T_{MIN} to T_{MAX} : 0°C to 70°C.
- ³Guaranteed by characterization.
- ⁴All digital input pins except pins $\overline{\text{RESET}}$ and RTC/SCRESET.
- ⁵Excluding all digital input pins except pins $\overline{\text{RESET}}$ and RTC/SCRESET.
- ⁶Full drive into 37.5 Ω load.
- ⁷DACs can output 35 mA typically at 3.3 V ($R_{SET} = 150\ \Omega$ and $R_L = 75\ \Omega$), optimum performance obtained at 18 mA DAC current ($R_{SET} = 300\ \Omega$ and $R_L = 150\ \Omega$).
- ⁸Minimum drive current (used with buffered/scaled output load).
- ⁹Power measurements are taken with Clock Frequency = 27 MHz. Max $T_J = 110^\circ\text{C}$.
- ¹⁰ I_{DAC} is the total current (min corresponds to 5 mA output per DAC, max corresponds to 38 mA output per DAC) to drive all four DACs. Turning off individual DACs reduces I_{DAC} correspondingly.
- ¹¹ I_{CCT} (Circuit Current) is the continuous current required to drive the device.

Specifications subject to change without notice.

ADV7175A/ADV7176A—SPECIFICATIONS

5 V DYNAMIC SPECIFICATIONS¹ ($V_{AA} = +4.75\text{ V} - 5.25\text{ V}$ ¹, $V_{REF} = 1.235\text{ V}$ $R_{SET} = 150\ \Omega$. All specifications T_{MIN} to T_{MAX} ² unless otherwise noted.)

| Parameter | Conditions ¹ | Min | Typ | Max | Units |
|---|-----------------------------|-----|-----|-----|---------|
| Filter Characteristics | | | | | |
| Luma Bandwidth ³ (Low-Pass Filter) | NTSC Mode | | | | |
| Stopband Cutoff | >54 dB Attenuation | 7.0 | | | MHz |
| Passband Cutoff $F_{3\text{ dB}}$ | >3 dB Attenuation | 4.2 | | | MHz |
| Chroma Bandwidth | NTSC Mode | | | | |
| Stopband Cutoff | >40 dB Attenuation | 3.2 | | | MHz |
| Passband Cutoff $F_{3\text{ dB}}$ | >3 dB Attenuation | 2.0 | | | MHz |
| Luma Bandwidth ³ (Low-Pass Filter) | PAL MODE | | | | |
| Stopband Cutoff | >50 dB Attenuation | 7.4 | | | MHz |
| Passband Cutoff $F_{3\text{ dB}}$ | >3 dB Attenuation | 5.0 | | | MHz |
| Chroma Bandwidth | PAL MODE | | | | |
| Stopband Cutoff | >40 dB Attenuation | 4.0 | | | MHz |
| Passband Cutoff $F_{3\text{ dB}}$ | >3 dB Attenuation | 2.4 | | | MHz |
| Differential Gain ⁴ | Normal Power Mode | | 0.4 | | % |
| Differential Phase ⁴ | Normal Power Mode | | 0.4 | | Degree |
| Differential Gain ⁴ | Lower Power Mode | | 2.0 | | % |
| Differential Phase ⁴ | Lower Power Mode | | 1.0 | | Degree |
| SNR ⁴ (Pedestal) | RMS | | 80 | | dB rms |
| SNR ⁴ (Pedestal) | Peak Periodic | | 70 | | dB p-p |
| SNR ⁴ (Ramp) | RMS | | 60 | | dB rms |
| SNR ⁴ (Ramp) | Peak Periodic | | 58 | | dB p-p |
| Hue Accuracy ⁴ | | | 0.5 | | Degree |
| Color Saturation Accuracy ⁴ | | | 1.0 | | % |
| Chroma Nonlinear Gain ⁴ | Referenced to 40 IRE | | 0.6 | | ±% |
| Chroma Nonlinear Phase ⁴ | NTSC | | 0.2 | | ±Degree |
| Chroma Nonlinear Phase ⁴ | PAL | | 0.4 | | ±Degree |
| Chroma/Luma Intermod ⁴ | Referenced to 714 mV (NTSC) | | 0.1 | | ±% |
| Chroma/Luma Intermod ⁴ | Referenced to 700 mV (PAL) | | 0.1 | | ±% |
| Chroma/Luma Gain Ineq ⁴ | | | 0.6 | | ±% |
| Chroma/Luma Delay Ineq ⁴ | | | 2.0 | | ns |
| Luminance Nonlinearity ⁴ | | | 1.0 | | ±% |
| Chroma AM Noise ⁴ | | | 66 | | dB |
| Chroma PM Noise ⁴ | | | 63 | | dB |

NOTES

¹The max/min specifications are guaranteed over this range. The max/min values are typical over 4.75 V to 5.25 V.

²Temperature range T_{MIN} to T_{MAX} : 0°C to +70°C.

³These specifications are for the low-pass filter only and guaranteed by design. For other internal filters, see Figure 4.

⁴Guaranteed by characterization.

Specifications subject to change without notice.

3.3 V DYNAMIC SPECIFICATIONS¹ ($V_{AA} = +3.0\text{ V} - 3.6\text{ V}^1$, $V_{REF} = 1.235\text{ V}$ $R_{SET} = 300\ \Omega$. All specifications T_{MIN} to T_{MAX} ² unless otherwise noted.)

| Parameter | Conditions ¹ | Min | Typ | Max | Units |
|---|-------------------------|-----|-----|-----|--------|
| Filter Characteristics | | | | | |
| Luma Bandwidth ³ (Low-Pass Filter) | NTSC Mode | | | | |
| Stopband Cutoff | >54 dB Attenuation | 7.0 | | | MHz |
| Passband Cutoff F_3 dB | >3 dB Attenuation | 4.2 | | | MHz |
| Chroma Bandwidth | NTSC Mode | | | | |
| Stopband Cutoff | >40 dB Attenuation | 3.2 | | | MHz |
| Passband Cutoff F_3 dB | >3 dB Attenuation | 2.0 | | | MHz |
| Luma Bandwidth ³ (Low-Pass Filter) | PAL MODE | | | | |
| Stopband Cutoff | >50 dB Attenuation | 7.4 | | | MHz |
| Passband Cutoff F_3 dB | >3 dB Attenuation | 5.0 | | | MHz |
| Chroma Bandwidth | PAL MODE | | | | |
| Stopband Cutoff | >40 dB Attenuation | 4.0 | | | MHz |
| Passband Cutoff F_3 dB | >3 dB Attenuation | 2.4 | | | MHz |
| Differential Gain ⁴ | Normal Power Mode | | 0.7 | | % |
| Differential Phase ⁴ | Normal Power Mode | | 0.5 | | Degree |
| SNR ⁴ (Pedestal) | RMS | | 75 | | dB rms |
| SNR ⁴ (Pedestal) | Peak Periodic | | 68 | | dB p-p |
| SNR ⁴ (Ramp) | RMS | | 58 | | dB rms |
| SNR ⁴ (Ramp) | Peak Periodic | | 56 | | dB p-p |
| Hue Accuracy ⁴ | | | 1.0 | | Degree |
| Color Saturation Accuracy ⁴ | | | 1.2 | | % |
| Luminance Nonlinearity ⁴ | | | 1.1 | | ±% |
| Chroma AM Noise ⁴ | NTSC | | 67 | | dB |
| Chroma PM Noise ⁴ | NTSC | | 63 | | dB |
| Chroma AM Noise ⁴ | PAL | | 64 | | dB |
| Chroma PM Noise ⁴ | PAL | | 63 | | dB |

NOTES

¹The max/min specifications are guaranteed over this range. The max/min values are typical over 3.0 V to 3.6 V.

²Temperature range T_{MIN} to T_{MAX} : 0°C to +70°C.

³These specifications are for the low-pass filter only and guaranteed by design. For other internal filters, see Figure 4.

⁴Guaranteed by characterization.

Specifications subject to change without notice.

ADV7175A/ADV7176A

5 V TIMING SPECIFICATIONS ($V_{AA} = 4.75\text{ V} - 5.25\text{ V}^1$, $V_{REF} = 1.235\text{ V}$ $R_{SET} = 150\ \Omega$. All specifications T_{MIN} to T_{MAX}^2 unless otherwise noted.)

| Parameter | Conditions | Min | Typ | Max | Units |
|--|--|-----|-----|---------------|---------------|
| MPU PORT ^{3, 4} | After This Period the First Clock Is Generated Relevant for Repeated Start Condition | | | | |
| SCLOCK Frequency | | 0 | | 100 | kHz |
| SCLOCK High Pulsewidth, t_1 | | 4.0 | | | μs |
| SCLOCK Low Pulsewidth, t_2 | | 4.7 | | | μs |
| Hold Time (Start Condition), t_3 | | 4.0 | | | μs |
| Setup Time (Start Condition), t_4 | | 4.7 | | | μs |
| Data Setup Time, t_5 | | 250 | | | ns |
| SDATA, SCLOCK Rise Time, t_6 | | | | 1 | μs |
| SDATA, SCLOCK Fall Time, t_7 | | | | 300 | ns |
| Setup Time (Stop Condition), t_8 | 4.7 | | | μs | |
| ANALOG OUTPUTS ^{3, 5} | | | | | |
| Analog Output Delay | | | 5 | | ns |
| DAC Analog Output Skew | | | 0 | | ns |
| CLOCK CONTROL AND PIXEL PORT ^{3, 6} | | | | | |
| F_{CLOCK} | | | 27 | | MHz |
| Clock High Time, t_9 | | 8 | | | ns |
| Clock Low Time, t_{10} | | 8 | | | ns |
| Data Setup Time, t_{11} | | 3.5 | | | ns |
| Data Hold Time, t_{12} | | 4 | | | ns |
| Control Setup Time, t_{11} | | 4 | | | ns |
| Control Hold Time, t_{12} | | 3 | | | ns |
| Digital Output Access Time, t_{13} | | | | 24 | ns |
| Digital Output Hold Time, t_{14} | | | 4 | | ns |
| Pipeline Delay, t_{15} | | | 37 | | Clock Cycles |
| TELETEXT PORT ^{3, 7} | | | | | |
| Digital Output Access Time, t_{16} | | | 20 | | ns |
| Data Setup Time, t_{17} | | | 1 | | ns |
| Data Hold Time, t_{18} | | | 2 | | ns |
| RESET CONTROL ^{3, 4} | | | | | |
| $\overline{\text{RESET}}$ Low Time | | 6 | | | ns |

NOTES

¹The max/min specifications are guaranteed over this range.

²Temperature range T_{MIN} to T_{MAX} : 0°C to +70°C.

³TTL input values are 0 to 3 volts, with input rise/fall times ≤ 3 ns, measured between the 10% and 90% points. Timing reference points at 50% for inputs and outputs. Analog output load ≤ 10 pF.

⁴Guaranteed by characterization.

⁵Output delay measured from the 50% point of the rising edge of CLOCK to the 50% point of full-scale transition.

⁶Pixel Port consists of the following:

Pixel Inputs: P15–P0
 Pixel Controls: $\overline{\text{HSYNC}}$, $\overline{\text{FIELD}}$ / $\overline{\text{VSYNC}}$, $\overline{\text{BLANK}}$
 Clock Input: CLOCK

⁷Teletext Port consists of the following:

Teletext Output: TTXREQ
 Teletext Input: TTX

Specifications subject to change without notice.

3.3 V TIMING SPECIFICATIONS ($V_{AA} = 3.0 - 3.6^1$, $V_{REF} = 1.235$ V $R_{SET} = 300 \Omega$. All specifications T_{MIN} to T_{MAX} ² unless otherwise noted.)

| Parameter | Conditions | Min | Typ | Max | Units |
|---|---|---|--------------|---------------------------------|---|
| MPU PORT ^{3, 4} SCLOCK Frequency SCLOCK High Pulsewidth, t_1 SCLOCK Low Pulsewidth, t_2 Hold Time (Start Condition), t_3 Setup Time (Start Condition), t_4 Data Setup Time, t_5 SDATA, SCLOCK Rise Time, t_6 SDATA, SCLOCK Fall Time, t_7 Setup Time (Stop Condition), t_8 | After This Period the First Clock Is Generated for Repeated Start Condition | 0 4.0 4.7 4.0 4.7 250 4.7 | | 100 1 300 | kHz μ s μ s μ s μ s ns μ s ns μ s |
| ANALOG OUTPUTS ^{3, 5} Analog Output Delay DAC Analog Output Skew | | | 7 0 | | ns ns |
| CLOCK CONTROL AND PIXEL PORT ^{3, 4, 6, 7} F_{CLOCK} Clock High Time, t_9 Clock Low Time, t_{10} Data Setup Time, t_{11} Data Hold Time, t_{12} Control Setup Time, t_{11} Control Hold Time, t_{12} Digital Output Access Time, t_{13} Digital Output Hold Time, t_{14} Pipeline Delay, t_{15} | | 8 8 3.5 4 4 3 | 27 | 24 | MHz ns ns ns ns ns ns ns ns Clock Cycles |
| TELETEXT PORT ^{3, 6, 8} Digital Output Access Time t_{16} Data Setup Time, t_{17} Data Hold Time, t_{18} | | | 23 2 2 | | ns ns ns |
| RESET CONTROL ^{3, 4} \overline{RESET} Low Time | | 6 | | | ns |

NOTES

¹The max/min specifications are guaranteed over this range.

²Temperature range T_{MIN} to T_{MAX} : 0°C to +70°C.

³TTL input values are 0 to 3 volts, with input rise/fall times ≤ 3 ns, measured between the 10% and 90% points. Timing reference points at 50% for inputs and outputs. Analog output load ≤ 10 pF.

⁴Guaranteed by characterization.

⁵Output delay measured from the 50% point of the rising edge of CLOCK to the 50% point of full-scale transition.

⁶Characterized by design.

⁷Pixel Port consists of the following:

Pixel Inputs: P15-P0
Pixel Controls: \overline{HSYNC} , \overline{FIELD} / \overline{VSYNC} , \overline{BLANK}
Clock Input: CLOCK

⁸Teletext Port consists of the following:

Teletext Output: TTXREQ
Teletext Input: TTX

Specifications subject to change without notice.

ADV7175A/ADV7176A

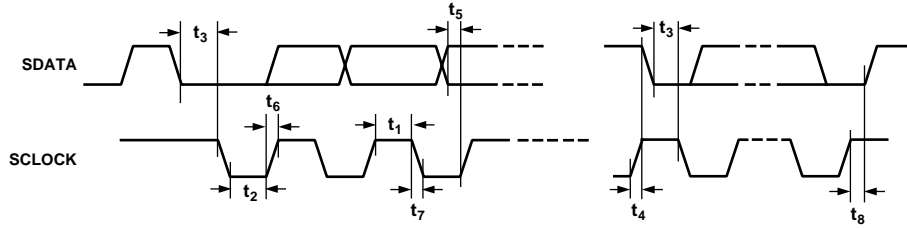

Figure 1. MPU Port Timing Diagram

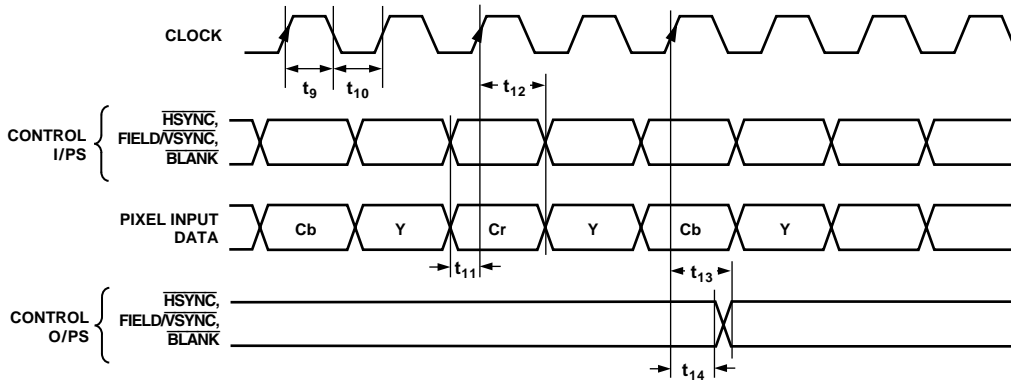

Figure 2. Pixel and Control Data Timing Diagram

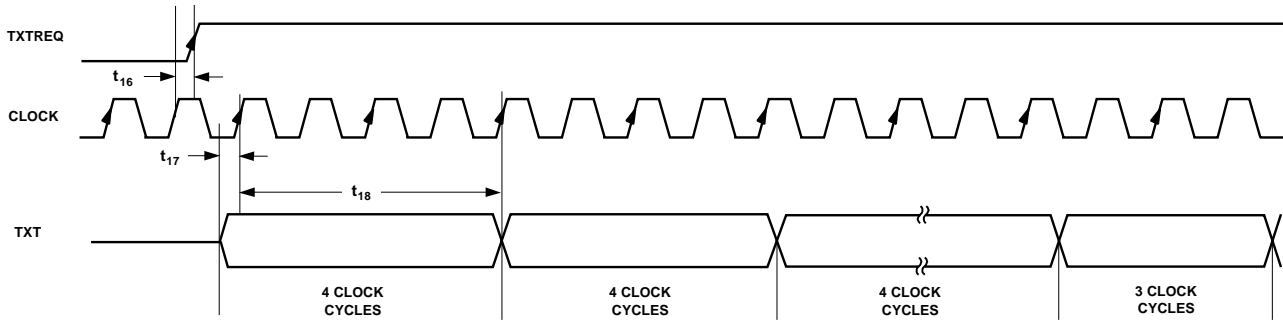

Figure 3. Teletext Timing Diagram

ABSOLUTE MAXIMUM RATINGS¹

| | |
|---------------------------------------|---------------------------------|
| V_{AA} to GND | 7 V |
| Voltage on Any Digital Input Pin | GND - 0.5 V to V_{AA} + 0.5 V |
| Storage Temperature (T_S) | -65°C to +150°C |
| Junction Temperature (T_J) | +150°C |
| Lead Temperature (Soldering, 10 secs) | +260°C |
| Analog Outputs to GND ² | GND - 0.5 to V_{AA} |

NOTES

¹Stresses above those listed under Absolute Maximum Ratings may cause permanent damage to the device. This is a stress rating only; functional operation of the device at these or any other conditions above those listed in the operational sections of this specification is not implied. Exposure to absolute maximum rating conditions for extended periods may affect device reliability.

²Analog output short circuit to any power supply or common can be of an indefinite duration.

PACKAGE THERMAL PERFORMANCE

The 44-PQFP package used for this device takes advantage of an ADI patented thermal coastline lead frame construction. This maximizes heat transfer into the leads and reduces the package thermal resistance.

The junction-to-ambient (θ_{JA}) thermal resistance in still air on a four-layer PCB is 35.5°C/W. The junction-to-case thermal resistance (θ_{JC}) is 13.75°C/W.

ORDERING GUIDE

| Model | Temperature Range | Package Description | Package Option |
|------------|-------------------|-----------------------|----------------|
| ADV7175AKS | 0°C to +70°C | Plastic Quad Flatpack | S-44 |
| ADV7176AKS | 0°C to +70°C | Plastic Quad Flatpack | S-44 |

PIN CONFIGURATION

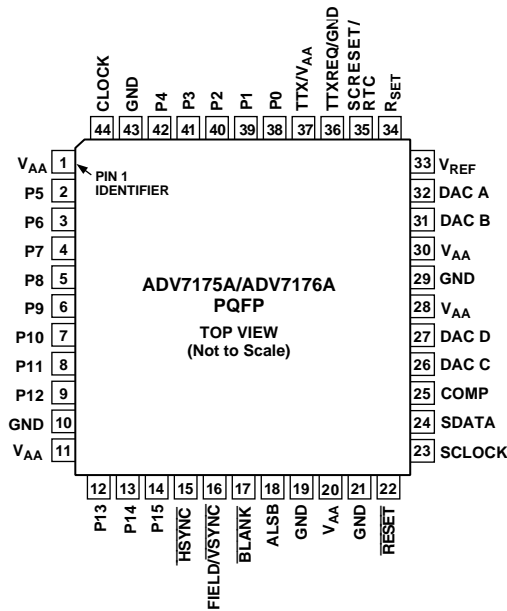

CAUTION

ESD (electrostatic discharge) sensitive device. Electrostatic charges as high as 4000 V readily accumulate on the human body and test equipment and can discharge without detection. Although the ADV7175A/ADV7176A feature proprietary ESD protection circuitry, permanent damage may occur on devices subjected to high energy electrostatic discharges. Therefore, proper ESD precautions are recommended to avoid performance degradation or loss of functionality.



ADV7175A/ADV7176A

PIN FUNCTION DESCRIPTIONS

| Pin No. | Mnemonic | Input/Output | Function |
|---------------------|----------------------------------|--------------|---|
| 1, 11, 20, 28, 30 | V _{AA} | P | Power Supply (+3 V to +5 V). |
| 10, 19, 21, 29, 43 | GND | G | Ground Pin. |
| 15 | $\overline{\text{HSYNC}}$ | I/O | $\overline{\text{HSYNC}}$ (Modes 1 and 2) Control Signal. This pin may be configured to output (Master Mode) or accept (Slave Mode) Sync signals. |
| 16 | FIELD/ $\overline{\text{VSYNC}}$ | I/O | Dual Function FIELD (Mode 1) and $\overline{\text{VSYNC}}$ (Mode 2) Control Signal. This pin may be configured to output (Master Mode) or accept (Slave Mode) these control signals. |
| 17 | $\overline{\text{BLANK}}$ | I/O | Video Blanking Control Signal. The pixel inputs are ignored when this is logic level "0." This signal is optional. |
| 18 | ALSB | I | TTL Address Input. This signal sets up the LSB of the MPU address. |
| 22 | $\overline{\text{RESET}}$ | I | The input resets the on chip timing generator and sets the ADV7175A/ADV7176A into default mode. This is NTSC operation, Timing Slave Mode 0, 8-bit operation, 2 × composite and S-Video out and all DACs powered on. |
| 23 | SCLOCK | I | MPU Port Serial Interface Clock Input. |
| 24 | SDATA | I/O | MPU Port Serial Data Input/Output. |
| 25 | COMP | O | Compensation Pin. Connect a 0.1 μF capacitor from COMP to V _{AA} . For Optimum Dynamic Performance in Low Power Mode, the value of the COMP capacitor can be lowered to as low as 2.2 nF. |
| 26 | DAC C | O | RED/S-Video C/V Analog Output. |
| 27 | DAC D | O | GREEN/S-Video Y/Y Analog Output. |
| 31 | DAC B | O | BLUE/Composite/U Analog Output. |
| 32 | DAC A | O | PAL/NTSC Composite Video Output. Full-Scale Output is 180IRE (1286 mV) for NTSC and 1300 mV for PAL. |
| 33 | V _{REF} | I/O | Voltage Reference Input for DACs or Voltage Reference Output (1.235 V). |
| 34 | R _{SET} | I | A 150 Ω resistor connected from this pin to GND is used to control full-scale amplitudes of the video signals. |
| 35 | SCRESET/RTC | I | This pin can be configured as an input by setting MR22 and MR21 of Mode Register 2. It can be configured as a subcarrier reset pin, in which case a high to low transition on this pin will reset the subcarrier to Field 0. Alternatively it may be configured as a Real Time Control (RTC) input. |
| 36 | TTXREQ/GND | O | Teletext Data Request Signal/Defaults to GND when Teletext not selected (enables backward compatibility to ADV7175/ADV7176). |
| 37 | TTX/V _{AA} | I | Teletext Data/Defaults to V _{AA} when Teletext not selected (enables backward compatibility to ADV7175/ADV7176). |
| 38–42 2–9, 12–14 | P0–P15 | I | 8-Bit 4:2:2 Multiplexed YCrCb Pixel Port (P7–P0) or 16-Bit YCrCb Pixel Port (P0–P15). P0 represents the LSB. |
| 44 | CLOCK | I | TTL Clock Input. Requires a stable 27 MHz reference Clock for standard operation. Alternatively, a 24.52 MHz (NTSC) or 29.5 MHz (PAL) can be used for square pixel operation. |

(Continued from page 1)

signal compatible with worldwide standards. The 4:2:2 YUV video data is interpolated to two times the pixel rate. The color-difference components (UV) are quadrature modulated using a subcarrier frequency generated by an on-chip 32-bit digital synthesizer (also running at two times the pixel rate). The two times pixel rate sampling allows for better signal-to-noise-ratio. A 32-bit DDS with a 10-bit look-up table produces a superior subcarrier in terms of both frequency and phase. In addition to the composite output signal, there is the facility to output S-Video (Y/C) video, YUV or RGB video. The Y/C, YUV or RGB format is simultaneously available at the analog outputs with the composite video signal.

Each analog output is capable of driving the full video-level (35 mA) signal into an unbuffered, doubly terminated 75 Ω load. With external buffering, the user has the additional option to scale back the DAC output current to 5 mA min, thereby significantly reducing the power dissipation of the device.

The ADV7175A/ADV7176A also supports both PAL and NTSC square pixel operation.

The output video frames are synchronized with the incoming data timing reference codes. Optionally the encoder accepts (and can generate) $\overline{\text{HSYNC}}$, $\overline{\text{VSYNC}}$ and FIELD timing signals. These timing signals can be adjusted to change pulsewidth and position while the part is in the master mode. The encoder requires a single two times pixel rate (27 MHz) clock for standard operation. Alternatively, the encoder requires a 24.54 MHz clock for NTSC or 29.5 MHz clock for PAL square pixel mode operation. All internal timing is generated on-chip.

A separate teletext port enables the user to directly input teletext data during the vertical blanking interval.

The ADV7175A/ADV7176A modes are set up over a two-wire serial bidirectional port (I²C Compatible) with two slave addresses.

Functionally the ADV7175A and ADV7176A are the same with the exception that the ADV7175A can output the Macrovision anticopy algorithm.

The ADV7175A/ADV7176A is packaged in a 44-lead thermally enhanced PQFP package.

DATA PATH DESCRIPTION

For PAL B, D, G, H, I, M, N and NTSC M modes, YCrCb 4:2:2 data is input via the CCIR-656 compatible pixel port at a 27 MHz Data Rate. The pixel data is demultiplexed to from three data paths. Y typically has a range of 16 to 235, Cr and Cb typically have a range of 128 ± 112 ; however, it is possible to input data from 1 to 254 on both Y, Cb and Cr. The ADV7175A/ADV7176A supports PAL (B, D, G, H, I, N, M) and NTSC (with and without Pedestal) standards. The appropriate SYNC, BLANK and Burst levels are added to the YCrCb data. Macrovision antitaping (ADV7175A only), closed captioning and teletext levels are also added to Y, and the resultant data is interpolated to a rate of 27 MHz. The interpolated data is filtered and scaled by three digital FIR filters.

The U and V signals are modulated by the appropriate subcarrier sine/cosine phases and added together to make up the chrominance signal. The luma (Y) signal can be delayed 1–3 luma cycles (each cycle is 74 ns) with respect to the chroma signal. The luma and chroma signals are then added together to make up the composite video signal. All edges are slew rate limited.

The YCrCb data is also used to generate RGB data with appropriate SYNC and BLANK levels. The RGB data is in synchronization with the composite video output. Alternatively analog YUV data can be generated instead of RGB.

The four 10-bit DACs can be used to output:

1. Composite Video + RGB Video.
2. Composite Video + YUV Video
3. Two Composite Video Signals + LUMA and CHROMA (Y/C) Signals.

Alternatively, each DAC can be individually powered off if not required.

Video output levels are illustrated in Appendix 4 and Appendix 5.

INTERNAL FILTER RESPONSE

The Y filter supports several different frequency responses, including two 4.5 MHz/5.0 MHz low pass responses, PAL/NTSC subcarrier notch responses and a PAL/NTSC extended response. The U and V filters have a 2/2.4 MHz low-pass response for NTSC/PAL. These filter characteristics are illustrated in Figures 4 to 12.

| FILTER SELECTION | PASSBAND CUTOFF (MHz) | | PASSBAND RIPPLE (dB) | STOPBAND CUTOFF (MHz) | STOPBAND ATTENUATION (dB) | F _{3dB} |
|------------------|-----------------------|------|----------------------|-----------------------|---------------------------|------------------|
| | MR04 | MR03 | | | | |
| NTSC | 0 | 0 | 2.3 | 7.0 | >54 | 4.2 |
| PAL | 0 | 0 | 3.4 | 7.3 | >50 | 5.0 |
| NTSC | 0 | 1 | 1.0 | 3.57 | >27.6 | 2.1 |
| PAL | 0 | 1 | 1.4 | 4.43 | >29.3 | 2.7 |
| NTSC/PAL | 1 | 0 | 4.0 | 7.5 | >40 | 5.65 |
| NTSC | 1 | 1 | 2.3 | 7.0 | >54 | 4.2 |
| PAL | 1 | 1 | 3.4 | 7.3 | >50.3 | 5.0 |

Figure 4. Luminance Internal Filter Specifications

| FILTER SELECTION | PASSBAND CUTOFF (MHz) | PASSBAND RIPPLE (dB) | STOPBAND CUTOFF (MHz) | STOPBAND ATTENUATION (dB) | ATTENUATION @ 1.3MHz (dB) | F _{3dB} |
|------------------|-----------------------|----------------------|-----------------------|---------------------------|---------------------------|------------------|
| NTSC | 1.0 | 0.085 | 3.2 | >40 | 0.3 | 2.05 |
| PAL | 1.3 | 0.04 | 4.0 | >40 | 0.02 | 2.45 |

Figure 5. Chrominance Internal Filter Specifications

ADV7175A/ADV7176A

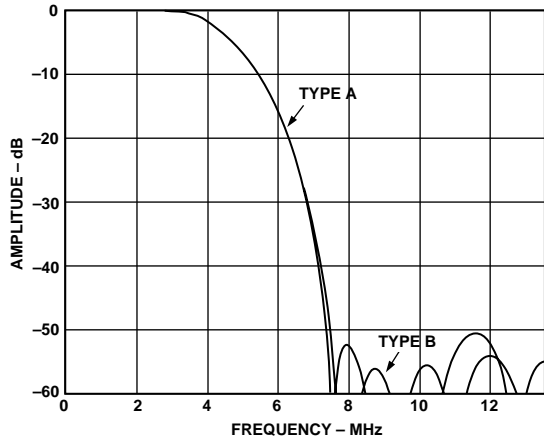

Figure 6. NTSC Low-Pass Filter

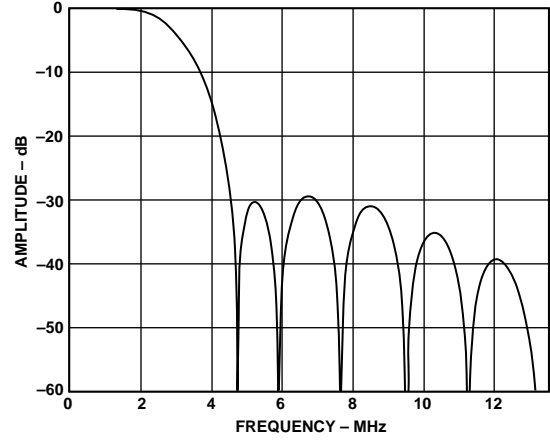

Figure 9. PAL Notch Filter

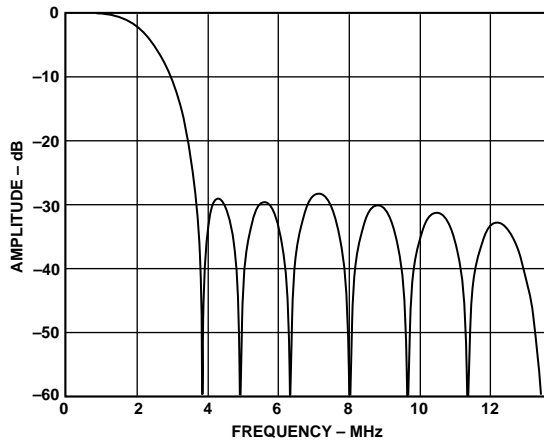

Figure 7. NTSC Notch Filter

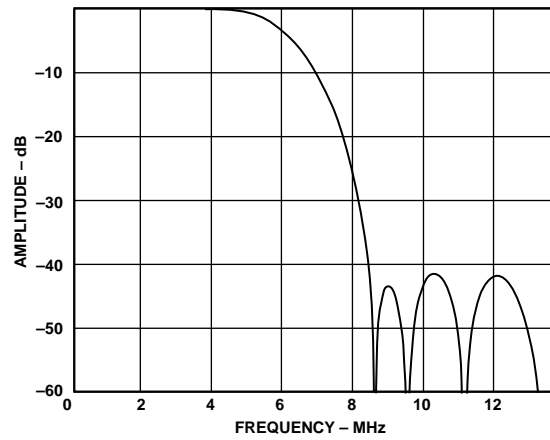

Figure 10. NTSC/PAL Extended Mode Filter

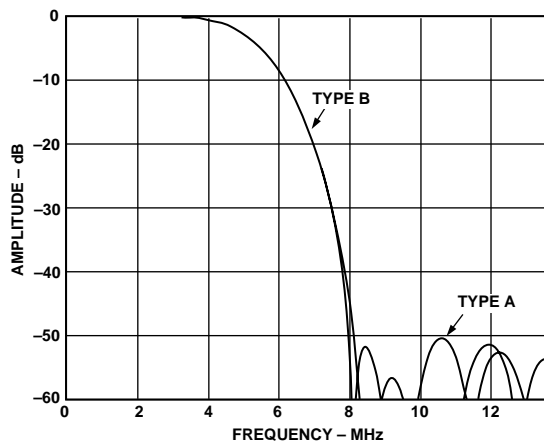

Figure 8. PAL Low-Pass Filter

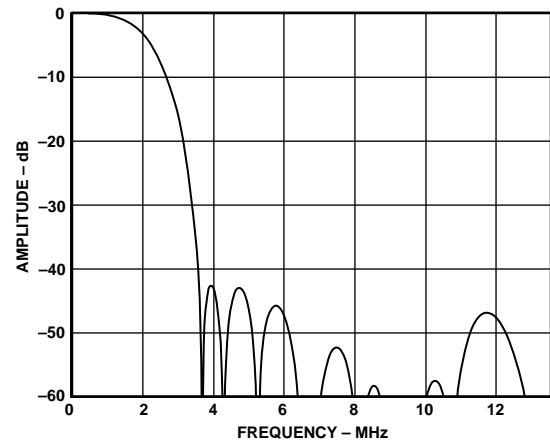

Figure 11. NTSC UV Filter

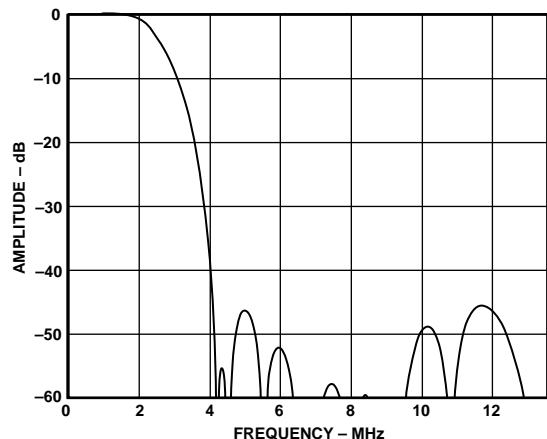

Figure 12. PAL UV Filter

COLOR BAR GENERATION

The ADV7175A/ADV7176A can be configured to generate 75% amplitude, 75% saturation (75/7.5/75/7.5) for NTSC or 75% amplitude, 100% saturation (100/0/75/0) for PAL color bars. These are enabled by setting MR17 of Mode Register 1 to Logic "1."

SQUARE PIXEL MODE

The ADV7175A/ADV7176A can be used to operate in square pixel mode. For NTSC operation an input clock of 24.5454 MHz is required. Alternatively an input clock of 29.5 MHz is required for PAL operation. The internal timing logic adjusts accordingly for square pixel mode operation.

COLOR SIGNAL CONTROL

The color information can be switched on and off the video output using Bit MR24 of Mode Register 2.

BURST SIGNAL CONTROL

The burst information can be switched on and off the video output using Bit MR25 of Mode Register 2.

NTSC PEDESTAL CONTROL

The pedestal on both odd and even fields can be controlled on a line by line basis using the NTSC Pedestal Control Registers. This allows the pedestals to be controlled during the vertical blanking interval (Lines 10 to 25 and Lines 273 to 288).

PIXEL TIMING DESCRIPTION

The ADV7175A/ADV7176A can operate in either 8-bit or 16-bit YCrCb Mode.

8-Bit YCrCb Mode

This default mode accepts multiplexed YCrCb inputs through the P7-P0 pixel inputs. The inputs follow the sequence Cb0, Y0 Cr0, Y1 Cb1, Y2, etc. The Y, Cb and Cr data are input on a rising clock edge.

16-Bit YCrCb Mode

This mode accepts Y inputs through the P7-P0 pixel inputs and multiplexed CrCb inputs through the P15-P8 pixel inputs. The data is loaded on every second rising edge of CLOCK. The inputs follow the sequence Cb0, Y0 Cr0, Y1 Cb1, Y2, etc.

SUBCARRIER RESET

Together with the SCRESET/RTC PIN and Bits MR22 and MR21 of Mode Register 2, the ADV7175A/ADV7176A can be used in subcarrier reset mode. The subcarrier will reset to Field 0 at the start of the following field when a low to high transition occurs on this input pin.

REAL TIME CONTROL

Together with the SCRESET/RTC PIN and Bits MR22 and MR21 of Mode Register 2, the ADV7175A/ADV7176A can be used to lock to an external video source. The real time control mode allows the ADV7175A/ADV7176A to automatically alter the subcarrier frequency to compensate for line length variation. When the part is connected to a device that outputs a digital datastream in the RTC format (such as an ADV7185 video decoder [see Figure 13]), the part will automatically change to the compensated subcarrier frequency on a line by line basis. This digital datastream is 67 bits wide and the subcarrier is contained in Bits 0 to 21. Each bit is two clock cycles long. 00HEX should be written to all four subcarrier frequency registers when using this mode.

VIDEO TIMING DESCRIPTION

The ADV7175A/ADV7176A is intended to interface to off-the-shelf MPEG1 and MPEG2 Decoders. Consequently, the ADV7175A/ADV7176A accepts 4:2:2 YCrCb Pixel Data via a CCIR-656 pixel port and has several video timing modes of operation that allow it to be configured as either system master video timing generator or a slave to the system video timing generator. The ADV7175A/ADV7176A generates all of the required horizontal and vertical timing periods and levels for the analog video outputs.

The ADV7175A/ADV7176A calculates the width and placement of analog sync pulses, blanking levels and color burst envelopes. Color bursts are disabled on appropriate lines, and serration and equalization pulses are inserted where required.

In addition the ADV7175A/ADV7176A supports a PAL or NTSC square pixel operation in slave mode. The part requires an input pixel clock of 24.5454 MHz for NTSC and an input pixel clock of 29.5 MHz for PAL. The internal horizontal line counters place the various video waveform sections in the correct location for the new clock frequencies.

The ADV7175A/ADV7176A has four distinct master and four distinct slave timing configurations. Timing Control is established with the bidirectional $\overline{\text{SYNC}}$, $\overline{\text{BLANK}}$ and $\overline{\text{FIELD}}$ / $\overline{\text{VSYNC}}$ pins. Timing Mode Register 1 can also be used to vary the timing pulsewidths and where they occur in relation to each other.

ADV7175A/ADV7176A

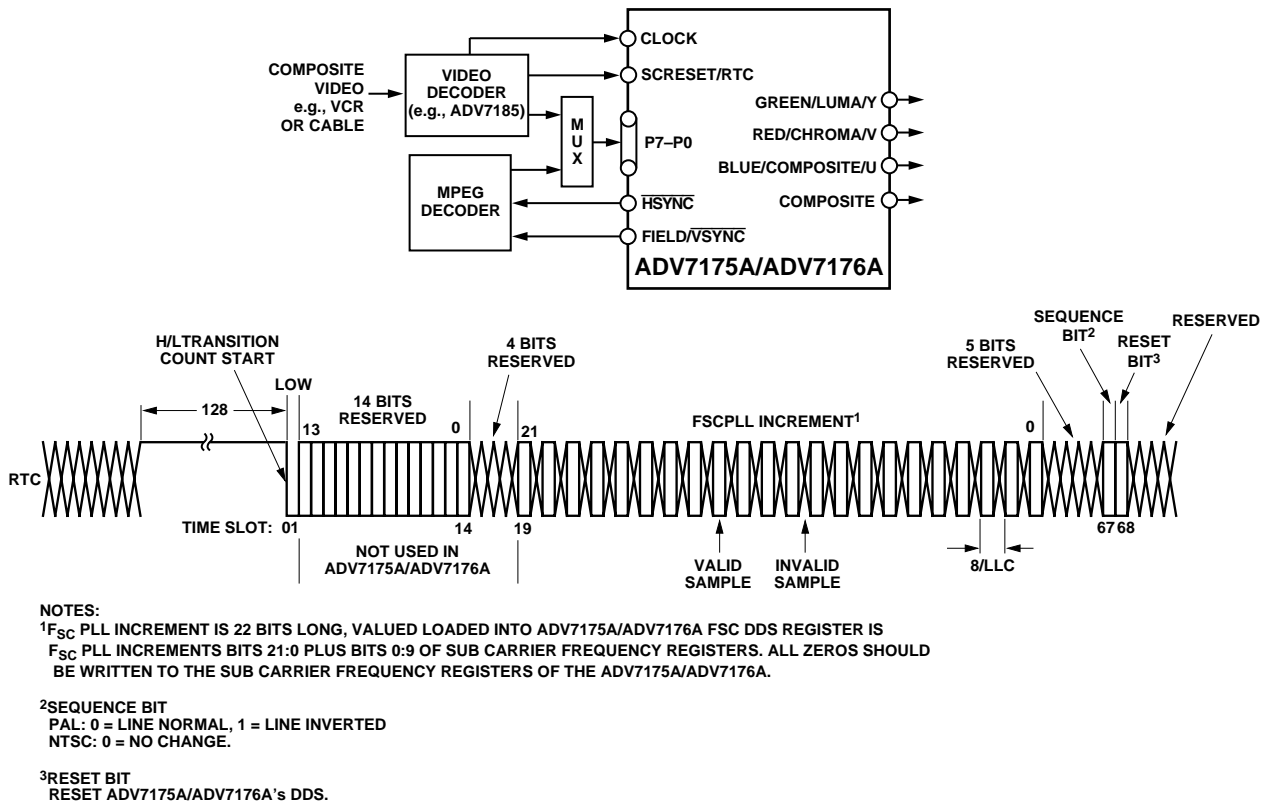

Figure 13. RTC Timing and Connections

Vertical Blanking Data Insertion

It is possible to allow encoding of incoming YCbCr data on those lines of VBI that do not bear line sync or pre/post-equalization pulses (see Figures 15 to 26). This mode of operation is called “Partial Blanking” and is selected by setting MR31 to 1. It allows the insertion of any VBI data (Opened VBI) into the encoded output waveform. This data is present in digitized incoming YCbCr data stream (e.g., WSS data, CGMS, VPS, etc.). Alternatively, the entire VBI may be blanked (no VBI data inserted) on these lines by setting MR31 to 0.

The complete VBI comprises of the following lines:

525/60 Systems, Lines 525 to 21 for Field 1 and Lines 262 to Line 284 for Field 2.

625/50 Systems, Lines 624 to Line 22 and Lines 311 to 335.

The “Opened VBI” consists of:

525/60 Systems, Lines 10 to 21 for Field 1 and second half of Line 273 to Line 284 for Field 2.

625/50 Systems, Line 7 to Line 22 and Lines 319 to 335.

Mode 0 (CCIR-656): Slave Option

(Timing Register 0 TR0 = X X X X X 0 0 0)

The ADV7175A/ADV7176A is controlled by the SAV (Start Active Video) and EAV (End Active Video) time codes in the pixel data. All timing information is transmitted using a 4-byte synchronization pattern. A synchronization pattern is sent immediately before and after each line during active picture and retrace. Mode 0 is illustrated in Figure 14. The $\overline{\text{HSYNC}}$, $\overline{\text{FIELD/VSYNC}}$ and $\overline{\text{BLANK}}$ (if not used) pins should be tied high during this mode.

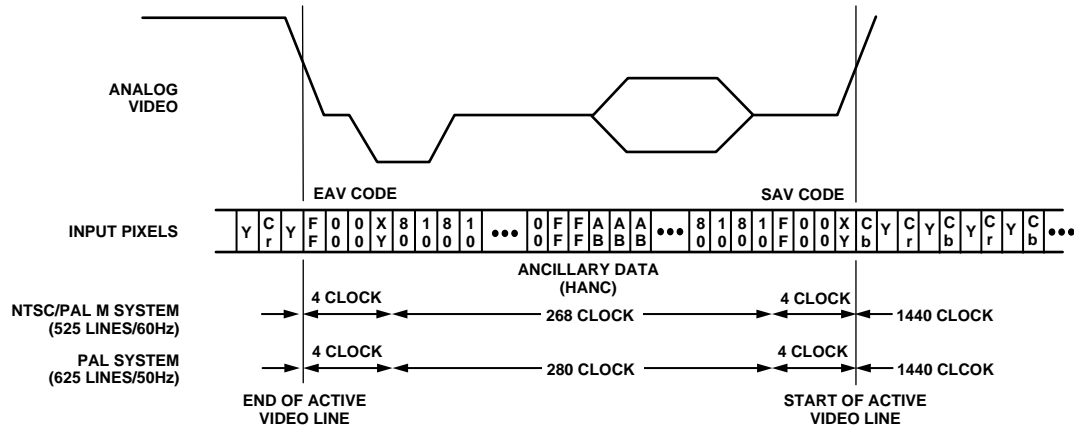

Figure 14. Timing Mode 0 (Slave Mode)

Mode 0 (CCIR-656): Master Option
 (Timing Register 0 TR0 = X X X X X 0 0 1)

The ADV7175A/ADV7176A generates H, V and F signals required for the SAV (Start Active Video) and EAV (End Active Video) time codes in the CCIR-656 standard. The H bit is output on the $\overline{\text{HSYNC}}$ pin, the V bit is output on the $\overline{\text{BLANK}}$ pin, and the F bit is output on the $\text{FIELD}/\overline{\text{VSYNC}}$ pin. Mode 0 is illustrated in Figure 15 (NTSC) and Figure 16 (PAL). The H, V and F transitions relative to the video waveform are illustrated in Figure 17.

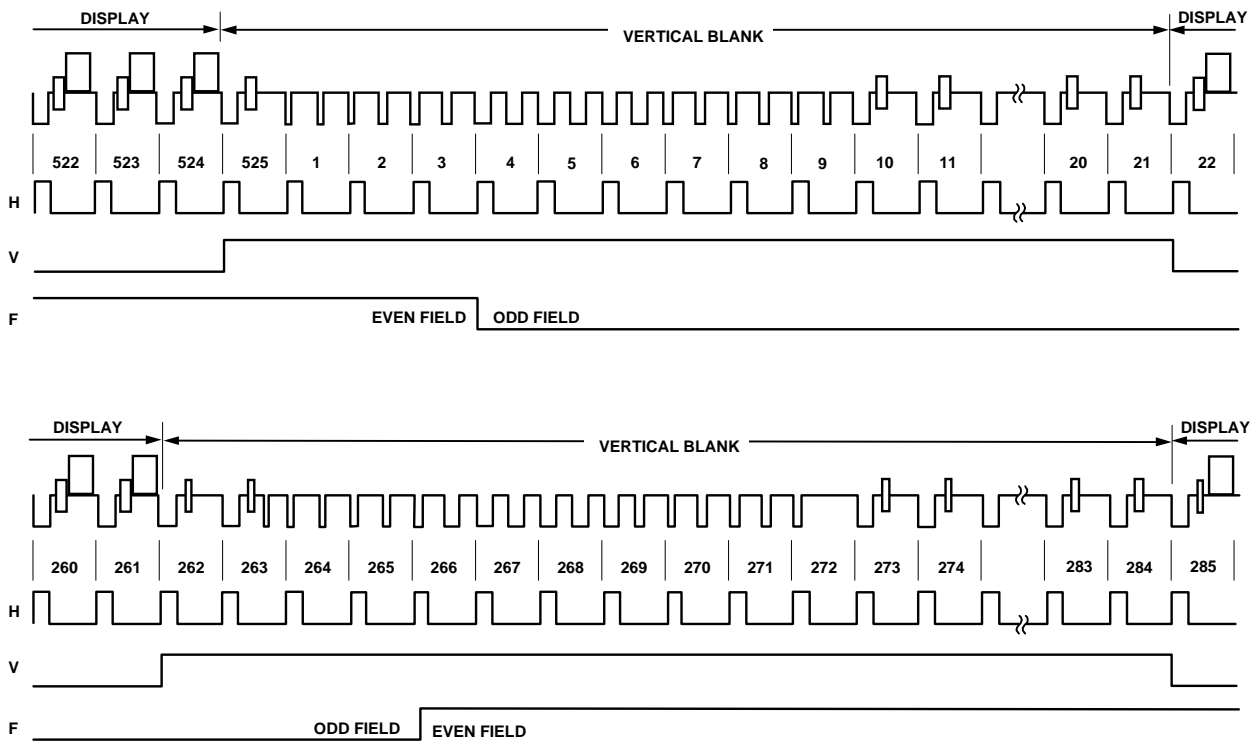

Figure 15. Timing Mode 0 (NTSC Master Mode)

ADV7175A/ADV7176A

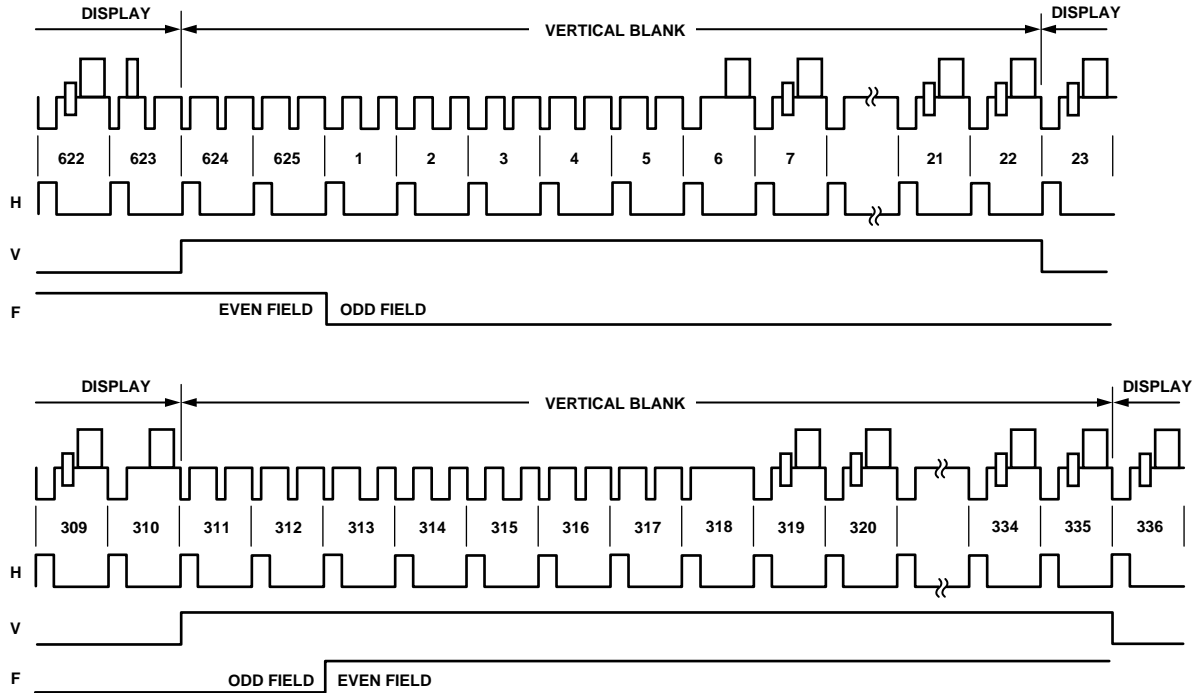

Figure 16. Timing Mode 0 (PAL Master Mode)

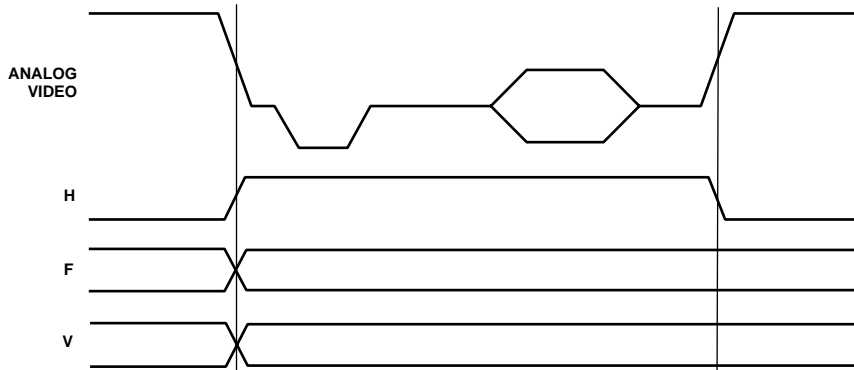

Figure 17. Timing Mode 0 Data Transitions (Master Mode)

Mode 1: Slave Option $\overline{\text{HSYNC}}$, $\overline{\text{BLANK}}$, $\overline{\text{FIELD}}$ (Timing Register 0 TR0 = X X X X X 0 1 0)

In this mode the ADV7175A/ADV7176A accepts horizontal SYNC and Odd/Even FIELD signals. A transition of the FIELD input when $\overline{\text{HSYNC}}$ is low indicates a new frame i.e., vertical retrace. The $\overline{\text{BLANK}}$ signal is optional. When the $\overline{\text{BLANK}}$ input is disabled the ADV7175A/ADV7176A automatically blanks all normally blank lines. Mode 1 is illustrated in Figure 18 (NTSC) and Figure 19 (PAL).

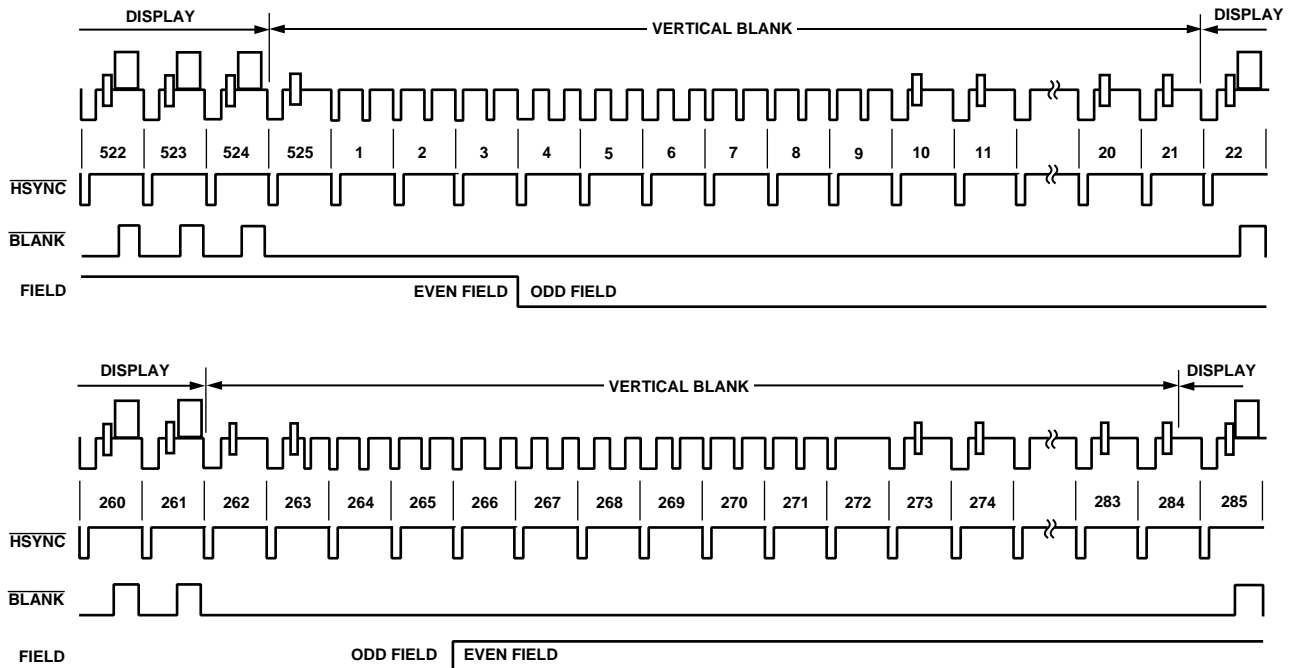

Figure 18. Timing Mode 1 (NTSC)

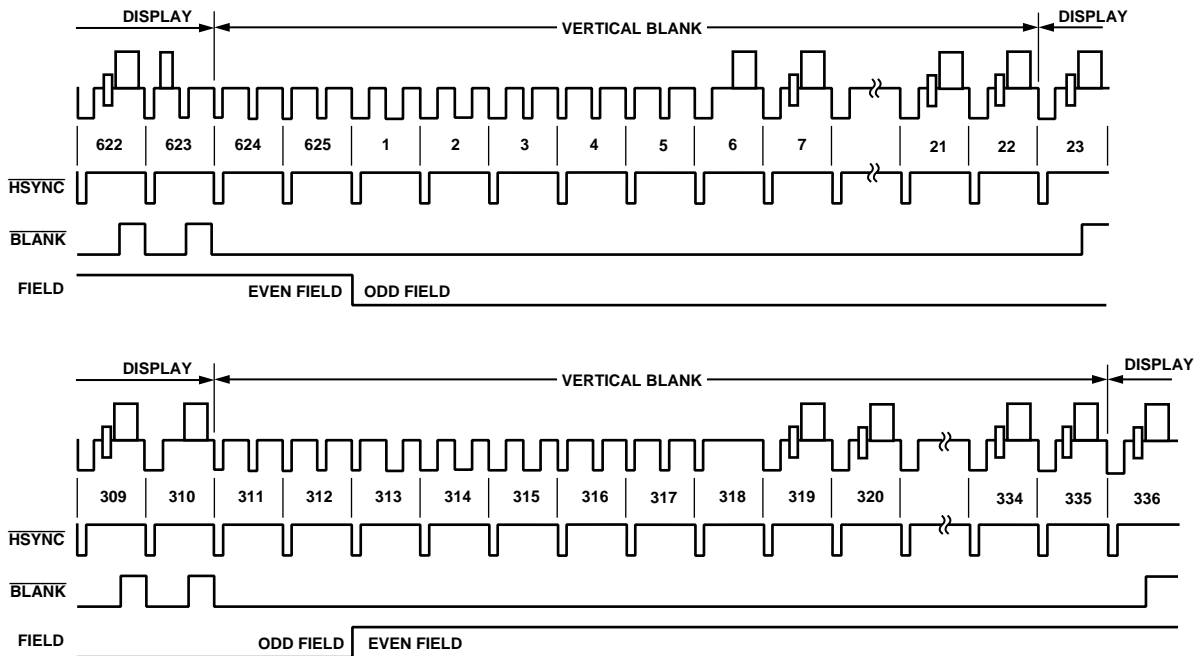

Figure 19. Timing Mode 1 (PAL)

Mode 1: Master Option $\overline{\text{HSYNC}}$, $\overline{\text{BLANK}}$, FIELD

(Timing Register 0 TR0 = X X X X X 0 1 1)

In this mode the ADV7175A/ADV7176A can generate horizontal SYNC and Odd/Even FIELD signals. A transition of the FIELD input when $\overline{\text{HSYNC}}$ is low indicates a new frame i.e., vertical retrace. The $\overline{\text{BLANK}}$ signal is optional. When the $\overline{\text{BLANK}}$ input is disabled, the ADV7175A/ADV7176A automatically blanks all normally blank lines. Pixel data is latched on the rising clock edge following the timing signal transitions. Mode 1 is illustrated in Figure 18 (NTSC) and Figure 19 (PAL). Figure 20 illustrates the $\overline{\text{HSYNC}}$, $\overline{\text{BLANK}}$ and FIELD for an odd or even field transition relative to the pixel data.

ADV7175A/ADV7176A

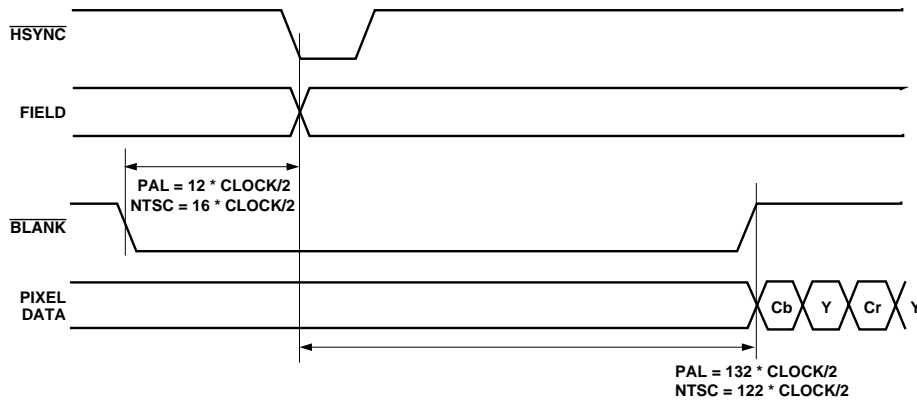

Figure 20. Timing Mode 1 Odd/Even Field Transitions Master/Slave

Mode 2: Slave Option $\overline{\text{HSYNC}}$, $\overline{\text{VSYNC}}$, $\overline{\text{BLANK}}$ (Timing Register 0 TR0 = X X X X X 1 0 0)

In this mode the ADV7175A/ADV7176A accepts horizontal and vertical SYNC signals. A coincident low transition of both $\overline{\text{HSYNC}}$ and $\overline{\text{VSYNC}}$ inputs indicates the start of an odd field. A $\overline{\text{VSYNC}}$ low transition when $\overline{\text{HSYNC}}$ is high indicates the start of an even field. The $\overline{\text{BLANK}}$ signal is optional. When the $\overline{\text{BLANK}}$ input is disabled, the ADV7175A/ADV7176A automatically blanks all normally blank lines as per CCIR-624. Mode 2 is illustrated in Figure 21 (NTSC) and Figure 22 (PAL).

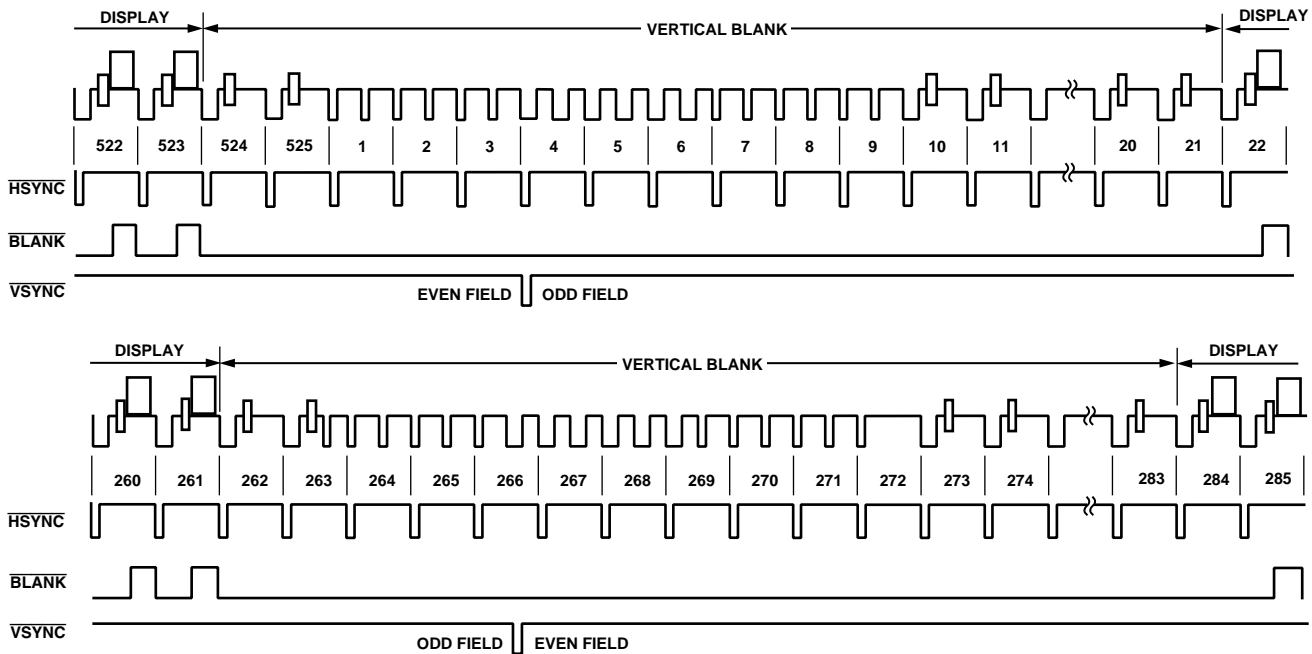

Figure 21. Timing Mode 2 (NTSC)

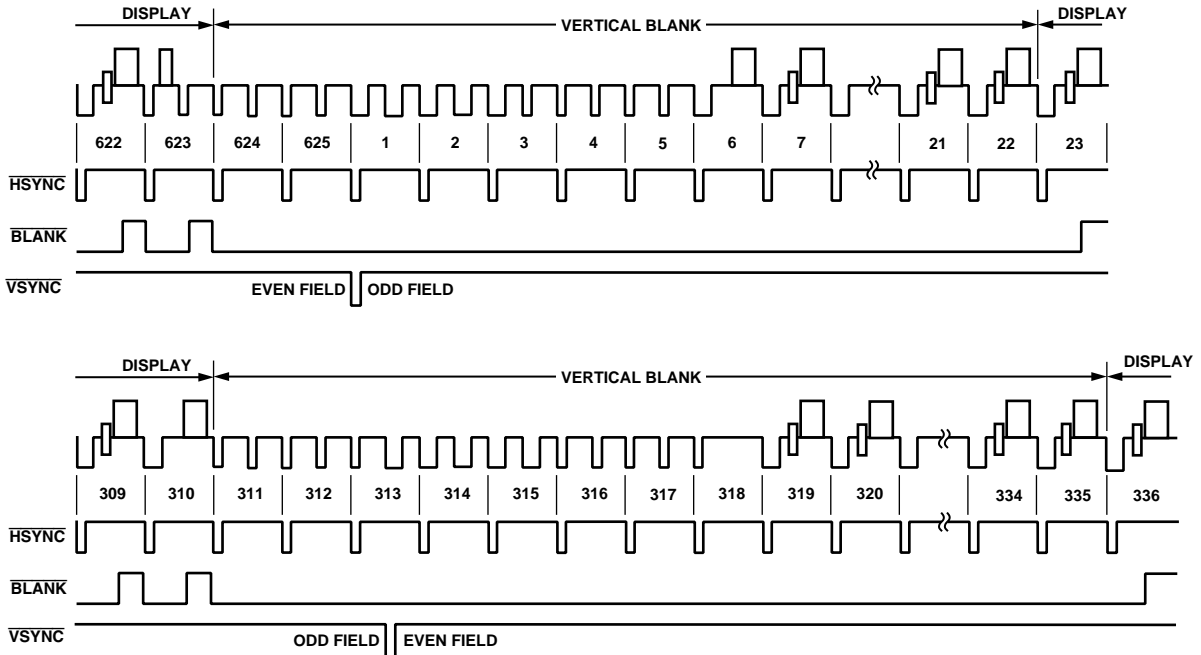

Figure 22. Timing Mode 2 (PAL)

Mode 2: Master Option $\overline{\text{HSYNC}}$, $\overline{\text{VSYNC}}$, $\overline{\text{BLANK}}$
 (Timing Register 0 TR0 = X X X X X 1 0 1)

In this mode, the ADV7175A/ADV7176A can generate horizontal and vertical SYNC signals. A coincident low transition of both $\overline{\text{HSYNC}}$ and $\overline{\text{VSYNC}}$ inputs indicates the start of an Odd Field. A $\overline{\text{VSYNC}}$ low transition when $\overline{\text{HSYNC}}$ is high indicates the start of an even field. The $\overline{\text{BLANK}}$ signal is optional. When the $\overline{\text{BLANK}}$ input is disabled, the ADV7175A/ADV7176A automatically blanks all normally blank lines as per CCIR-624. Mode 2 is illustrated in Figure 21 (NTSC) and Figure 22 (PAL). Figure 23 illustrates the $\overline{\text{HSYNC}}$, $\overline{\text{BLANK}}$ and $\overline{\text{VSYNC}}$ for an even-to-odd field transition relative to the pixel data. Figure 24 illustrates the $\overline{\text{HSYNC}}$, $\overline{\text{BLANK}}$ and $\overline{\text{VSYNC}}$ for an odd-to-even field transition relative to the pixel data.

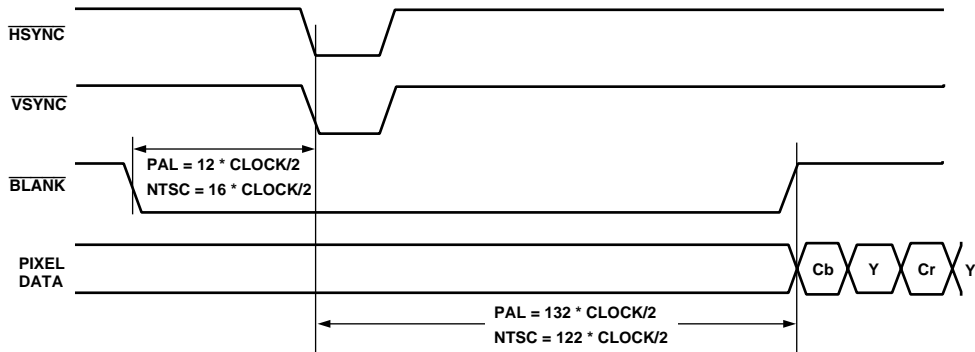

Figure 23. Timing Mode 2 Even-to-Odd Field Transition Master/Slave

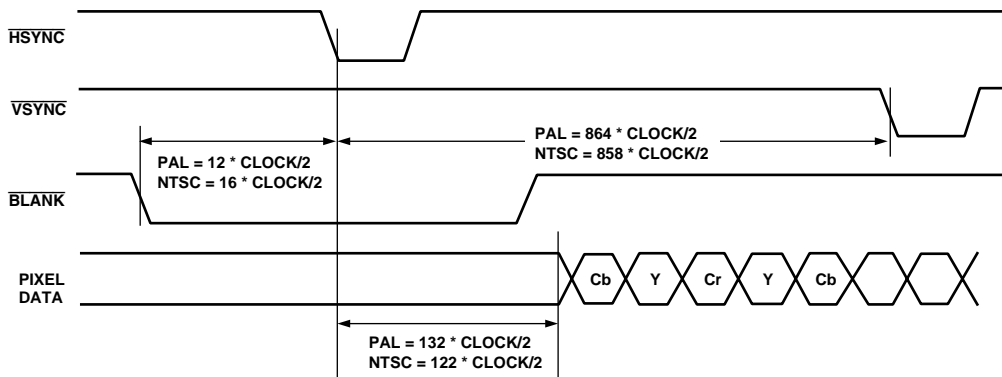

Figure 24. Timing Mode 2 Odd-to-Even Field Transition Master/Slave

ADV7175A/ADV7176A

Mode 3: Master/Slave Option $\overline{\text{HSYNC}}$, $\overline{\text{BLANK}}$, FIELD

(Timing Register 0 TR0 = X X X X X 1 1 0 or X X X X X 1 1 1)

In this mode, the ADV7175A/ADV7176A accepts or generates Horizontal SYNC and Odd/Even FIELD signals. A transition of the FIELD input when $\overline{\text{HSYNC}}$ is high indicates a new frame i.e., vertical retrace. The $\overline{\text{BLANK}}$ signal is optional. When the $\overline{\text{BLANK}}$ input is disabled, the ADV7175A/ADV7176A automatically blanks all normally blank lines as per CCIR-624. Mode 3 is illustrated in Figure 25 (NTSC) and Figure 26 (PAL).

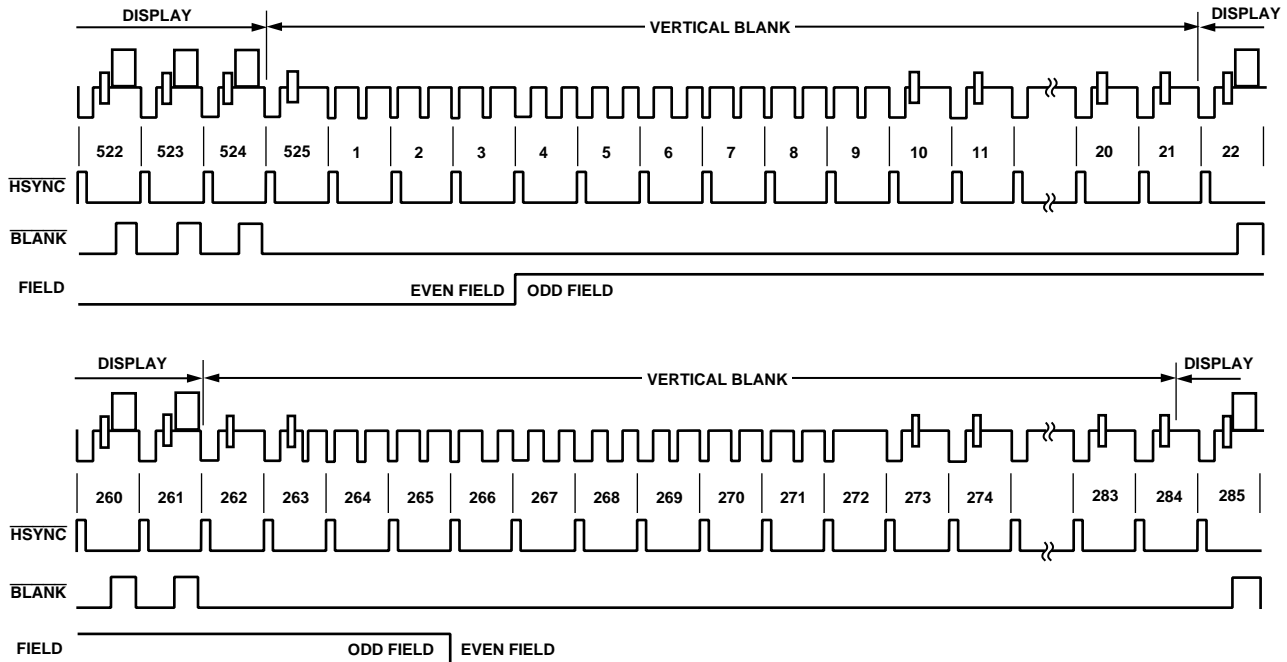

Figure 25. Timing Mode 3 (NTSC)

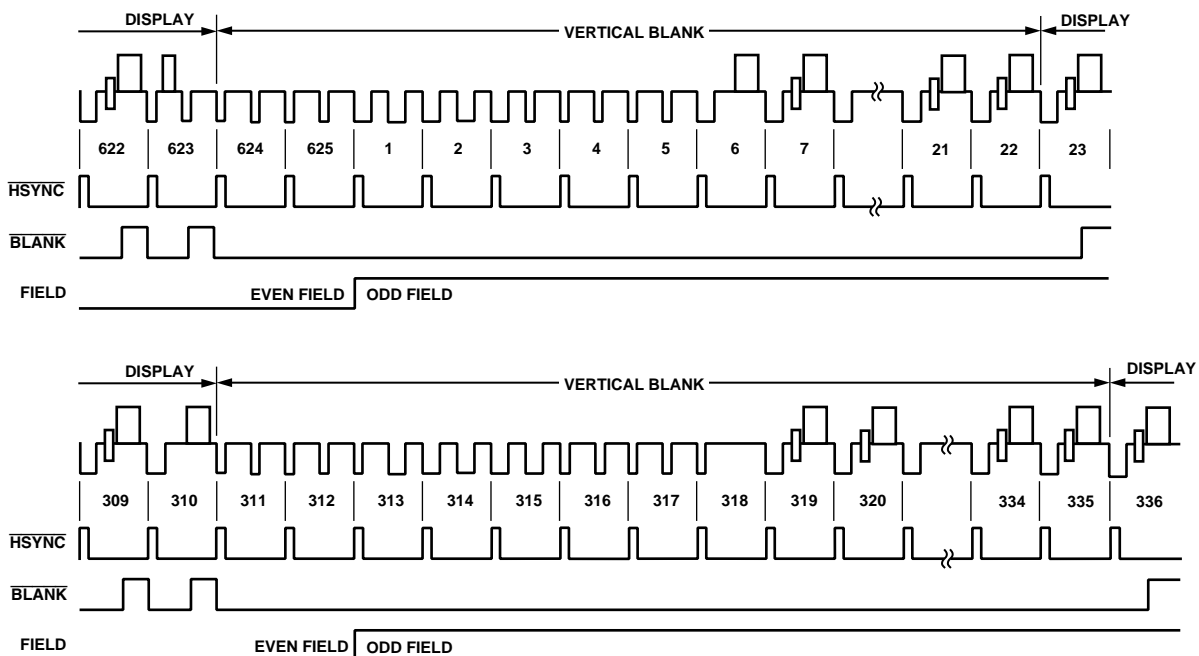

Figure 26. Timing Mode 3 (PAL)

OUTPUT VIDEO TIMING

The video timing generator generates the appropriate SYNC, BLANK and BURST sequence that controls the output analog waveforms. These sequences are summarized below. In slave modes, the following sequences are synchronized with the input timing control signals. In master modes, the timing generator free runs and generates the following sequences in addition to the output timing control signals.

NTSC-Interlaced: Scan Lines 1–9 and 264–272 are always blanked and vertical sync pulses are included. Scan Lines 525, 10–21 and 262, 263, 273–284 are also blanked and can be used for closed captioning data. Burst is disabled on lines 1–6, 261–269 and 523–525.

NTSC-Noninterlaced: Scan Lines 1–9 are always blanked, and vertical sync pulses are included. Scan Lines 10–21 are also blanked and can be used for closed captioning data. Burst is disabled on Lines 1–6, 261–262.

PAL-Interlaced: Scan Lines 1–6, 311–318 and 624–625 are always blanked, and vertical sync pulses are included in Fields 1, 2, 5 and 6. Scan Lines 1–5, 311–319 and 624–625 are always blanked, and vertical sync pulses are included in Fields 3, 4, 7 and 8. The remaining scan lines in the vertical blanking interval are also blanked and can be used for teletext data. Burst is disabled on Lines 1–6, 311–318 and 623–625 in Fields 1, 2, 5 and 6. Burst is disabled on Lines 1–5, 311–319 and 623–625 in Fields 3, 4, 7 and 8.

PAL-Noninterlaced: Scan Lines 1–6 and 311–312 are always blanked, and vertical sync pulses are included. The remaining scan lines in the vertical blanking interval are also blanked and can be used for teletext data. Burst is disabled on Lines 1–5, 310–312.

POWER-ON RESET

After power-up, it is necessary to execute a reset operation. A reset occurs on the falling edge of a high-to-low transition on the RESET pin. This initializes the pixel port so that the pixel inputs, P7–P0 are selected. After reset, the ADV7175A/ADV7176A is automatically set up to operate in NTSC mode. Subcarrier frequency code 21F07C16HEX is loaded into the subcarrier frequency registers. All other registers, with the exception of Mode Register 0, are set to 00H. All bits in Mode Register 0 are set to Logic Level “0” except Bit MR02. Bit MR02 of Mode Register 0 is set to Logic “1.” This enables the 7.5 IRE pedestal.

SCH Phase Mode

The SCH phase is configured in default mode to reset every four (NTSC) or eight (PAL) fields to avoid an accumulation of SCH phase error over time. In an ideal system, zero SCH phase error would be maintained forever, but in reality, this is impossible to achieve due to clock frequency variations. This effect is reduced by the use of a 32-bit DDS, which generates this SCH.

Resetting the SCH phase every four or eight fields avoids the accumulation of SCH phase error, and results in very minor SCH phase jumps at the start of the four or eight field sequence.

Resetting the SCH phase should not be done if the video source does not have stable timing or the ADV7175A/ADV7176A is configured in RTC mode (MR21 = 1 and MR22 = 1). Under these conditions (unstable video) the subcarrier phase reset should be enabled (MR22 = 0 and MR21 = 1) but no reset

applied. In this configuration the SCH phase will never be reset, which means that the output video will now track the unstable input video. The subcarrier phase reset, when applied, will reset the SCH phase to Field 0 at the start of the next field (e.g., subcarrier phase reset applied in Field 5 [PAL] on the start of the next field SCH phase will be reset to Field 0).

MPU PORT DESCRIPTION

The ADV7175A and ADV7176A support a two-wire serial (I²C Compatible) microprocessor bus driving multiple peripherals. Two inputs, serial data (SDATA) and serial clock (SCLOCK), carry information between any device connected to the bus. Each slave device is recognized by a unique address. The ADV7175A and ADV7176A each have four possible slave addresses for both read and write operations. These are unique addresses for each device and are illustrated in Figure 27 and Figure 28. The LSB sets either a read or write operation. Logic Level “1” corresponds to a read operation, while Logic Level “0” corresponds to a write operation. A1 is set by setting the ALSB pin of the ADV7175A/ADV7176A to Logic Level “0” or Logic Level “1.”

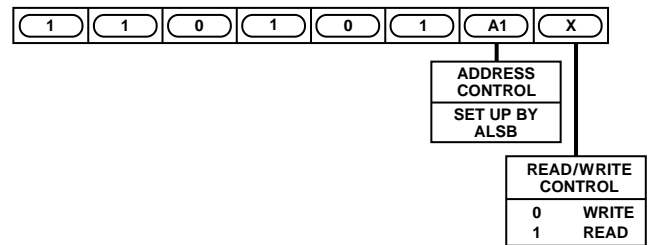

Figure 27. ADV7175A Slave Address

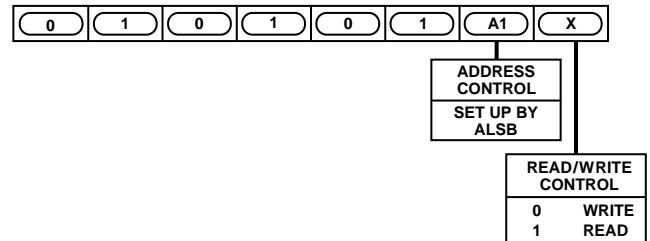

Figure 28. ADV7176A Slave Address

To control the various devices on the bus, the following protocol must be followed: First, the master initiates a data transfer by establishing a start condition, defined by a high-to-low transition on SDATA while SCLOCK remains high. This indicates that an address/data stream will follow. All peripherals respond to the start condition and shift the next eight bits (7-bit address + R/W bit). The bits transfer from MSB down to LSB. The peripheral that recognizes the transmitted address responds by pulling the data line low during the ninth clock pulse. This is known as an acknowledge bit. All other devices withdraw from the bus at this point and maintain an idle condition. The idle condition is where the device monitors the SDATA and SCLOCK lines waiting for the start condition and the correct transmitted address. The R/W bit determines the direction of the data. A Logic “0” on the LSB of the first byte means that the master will write information to the peripheral. A Logic “1” on the LSB of the first byte means that the master will read information from the peripheral.

ADV7175A/ADV7176A

The ADV7175A/ADV7176A acts as a standard slave device on the bus. The data on the SDATA pin is 8 bits long, supporting the 7-bit addresses, plus the R/W bit. The ADV7175A has 33 subaddresses and the ADV7176A has 19 subaddresses to enable access to the internal registers. It therefore interprets the first byte as the device address and the second byte as the starting subaddress. The subaddresses auto increment allow data to be written to or read from the starting subaddress. A data transfer is always terminated by a stop condition. The user can also access any unique subaddress register on a one by one basis without having to update all the registers. There is one exception. The subcarrier frequency registers should be updated in sequence, starting with Subcarrier Frequency Register 0. The auto increment function should then be used to increment and access Subcarrier Frequency Registers 1, 2 and 3. The subcarrier frequency registers should not be accessed independently.

Stop and start conditions can be detected at any stage during the data transfer. If these conditions are asserted out of sequence with normal read and write operations, they cause an immediate jump to the idle condition. During a given SCLOCK high period, the user should issue only one start condition, one stop condition or a single stop condition followed by a single start condition. If an invalid subaddress is issued by the user, the ADV7175A/ADV7176A will not issue an acknowledge and will

return to the idle condition. If, in auto-increment mode the user exceeds the highest subaddress, the following action will be taken:

1. In Read Mode, the highest subaddress register contents will continue to be output until the master device issues a no-acknowledge. This indicates the end of a read. A no-acknowledge condition is where the SDATA line is not pulled low on the ninth pulse.
2. In Write Mode, the data for the invalid byte will not be loaded into any subaddress register, a no-acknowledge will be issued by the ADV7175A/ADV7176A and the part will return to the idle condition.

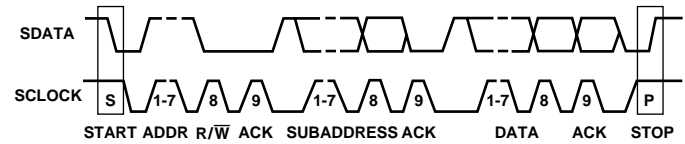

Figure 29. Bus Data Transfer

Figure 29 illustrates an example of data transfer for a read sequence and the start and stop conditions.

Figure 30 shows bus write and read sequences.

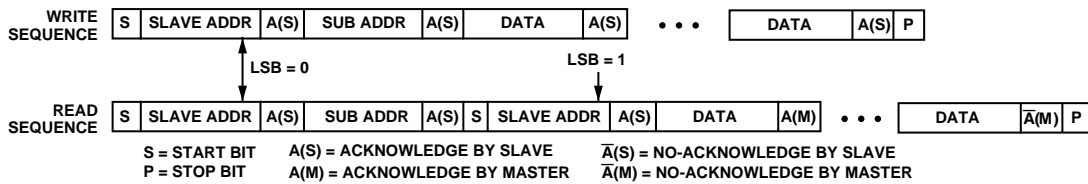

Figure 30. Write and Read Sequences

| SR7 | SR6 | SR5 | SR4 | SR3 | SR2 | SR1 | SR0 |
|--------------------------------------|-----|-----|-----|-----|-----|--|-----|
| SR7-SR6 (00) | | | | | | | |
| ZERO SHOULD BE WRITTEN TO THESE BITS | | | | | | | |
| ADV7175A SUBADDRESS REGISTER | | | | | | | |
| SR5 | SR4 | SR3 | SR2 | SR1 | SR0 | | |
| 0 | 0 | 0 | 0 | 0 | 0 | MODE REGISTER 0 | |
| 0 | 0 | 0 | 0 | 0 | 1 | MODE REGISTER 1 | |
| 0 | 0 | 0 | 0 | 1 | 0 | SUB CARRIER FREQ REGISTER 0 | |
| 0 | 0 | 0 | 0 | 1 | 1 | SUB CARRIER FREQ REGISTER 1 | |
| 0 | 0 | 0 | 1 | 0 | 0 | SUB CARRIER FREQ REGISTER 2 | |
| 0 | 0 | 0 | 1 | 0 | 1 | SUB CARRIER FREQ REGISTER 3 | |
| 0 | 0 | 0 | 1 | 1 | 0 | SUB CARRIER PHASE REGISTER | |
| 0 | 0 | 0 | 1 | 1 | 1 | TIMING REGISTER 0 | |
| 0 | 0 | 1 | 0 | 0 | 0 | CLOSED CAPTIONING EXTENDED DATA = BYTE 0 | |
| 0 | 0 | 1 | 0 | 0 | 1 | CLOSED CAPTIONING EXTENDED DATA = BYTE 1 | |
| 0 | 0 | 1 | 0 | 1 | 0 | CLOSED CAPTIONING DATA = BYTE 0 | |
| 0 | 0 | 1 | 0 | 1 | 1 | CLOSED CAPTIONING DATA = BYTE 1 | |
| 0 | 0 | 1 | 1 | 0 | 0 | TIMING REGISTER 1 | |
| 0 | 0 | 1 | 1 | 0 | 1 | MODE REGISTER 2 | |
| 0 | 0 | 1 | 1 | 1 | 0 | NTSC PEDESTAL CONTROL REG 0 (FIELD 1/3)/TTX SETUP REG 0* | |
| 0 | 0 | 1 | 1 | 1 | 1 | NTSC PEDESTAL CONTROL REG 1 (FIELD 1/3)/TTX SETUP REG 1* | |
| 0 | 1 | 0 | 0 | 0 | 0 | NTSC PEDESTAL CONTROL REG 2 (FIELD 2/4)/TTX SETUP REG 2* | |
| 0 | 1 | 0 | 0 | 0 | 1 | NTSC PEDESTAL CONTROL REG 3 (FIELD 2/4)/TTX SETUP REG 3* | |
| 0 | 1 | 0 | 0 | 1 | 0 | MODE REGISTER 3 | |
| 0 | 1 | 0 | 0 | 1 | 1 | MACROVISION REGISTER | |
| . | . | . | . | . | . | " " | |
| . | . | . | . | . | . | " " | |
| 1 | 0 | 0 | 0 | 1 | 1 | MACROVISION REGISTER | |
| 1 | 0 | 0 | 1 | 0 | 0 | TTXRQ CONTROL REGISTER 0 | |
| ADV7176A SUBADDRESS REGISTER | | | | | | | |
| SR5 | SR4 | SR3 | SR2 | SR1 | SR0 | | |
| 0 | 0 | 0 | 0 | 0 | 0 | MODE REGISTER 0 | |
| 0 | 0 | 0 | 0 | 0 | 1 | MODE REGISTER 1 | |
| 0 | 0 | 0 | 0 | 1 | 0 | SUB CARRIER FREQ REGISTER 0 | |
| 0 | 0 | 0 | 0 | 1 | 1 | SUB CARRIER FREQ REGISTER 1 | |
| 0 | 0 | 0 | 1 | 0 | 0 | SUB CARRIER FREQ REGISTER 2 | |
| 0 | 0 | 0 | 1 | 0 | 1 | SUB CARRIER FREQ REGISTER 3 | |
| 0 | 0 | 0 | 1 | 1 | 0 | SUB CARRIER PHASE REGISTER | |
| 0 | 0 | 0 | 1 | 1 | 1 | TIMING REGISTER 0 | |
| 0 | 0 | 1 | 0 | 0 | 0 | CLOSED CAPTIONING EXTENDED DATA = BYTE 0 | |
| 0 | 0 | 1 | 0 | 0 | 1 | CLOSED CAPTIONING EXTENDED DATA = BYTE 1 | |
| 0 | 0 | 1 | 0 | 1 | 0 | CLOSED CAPTIONING DATA = BYTE 0 | |
| 0 | 0 | 1 | 0 | 1 | 1 | CLOSED CAPTIONING DATA = BYTE 1 | |
| 0 | 0 | 1 | 1 | 0 | 0 | TIMING REGISTER 1 | |
| 0 | 0 | 1 | 1 | 0 | 1 | MODE REGISTER 2 | |
| 0 | 0 | 1 | 1 | 1 | 0 | NTSC PEDESTAL CONTROL REG 0 (FIELD 1/3)/TTX SETUP REG 0* | |
| 0 | 0 | 1 | 1 | 1 | 1 | NTSC PEDESTAL CONTROL REG 1 (FIELD 1/3)/TTX SETUP REG 1* | |
| 0 | 1 | 0 | 0 | 0 | 0 | NTSC PEDESTAL CONTROL REG 2 (FIELD 2/4)/TTX SETUP REG 2* | |
| 0 | 1 | 0 | 0 | 0 | 1 | NTSC PEDESTAL CONTROL REG 3 (FIELD 2/4)/TTX SETUP REG 3* | |
| 0 | 1 | 0 | 0 | 1 | 0 | MODE REGISTER 3 | |
| 1 | 0 | 0 | 1 | 0 | 0 | TTXRQ CONTROL REGISTER 0 | |

*TTX REGISTERS ARE AVAILABLE IN PAL MODE ONLY
IN NTSC MODE THESE REGISTERS CONTROL PEDESTAL

Figure 31. Subaddress Register

REGISTER ACCESSES

The MPU can write to or read from all of the ADV7175A/ADV7176A registers except the subaddress register, which is a write-only register. The subaddress register determines which register the next read or write operation accesses. All communications with the part through the bus start with an access to the subaddress register. A read/write operation is performed from/to the target address, which then increments to the next address until a stop command on the bus is performed.

REGISTER PROGRAMMING

The following section describes each register, including subaddress register, mode registers, subcarrier frequency registers, subcarrier phase register, timing registers, closed captioning extended data registers, closed captioning data registers and NTSC pedestal control registers in terms of its configuration.

Subaddress Register (SR7–SR0)

The communications register is an 8-bit write-only register. After the part has been accessed over the bus, and a read/write operation is selected, the subaddress is set up. The subaddress register determines to/from which register the operation takes place.

Figure 31 shows the various operations under the control of the subaddress register. Zero should always be written to SR7–SR6.

Register Select (SR5–SR0)

These bits are set up to point to the required starting address.

MODE REGISTER 0 MR0 (MR07–MR00)

(Address [SR4–SR0] = 00H)

Figure 32 shows the various operations under the control of Mode Register 0. This register can be read from as well as written to.

MR0 BIT DESCRIPTION

Encode Mode Control (MR01–MR00)

These bits are used to set up the encode mode. The ADV7175A/ADV7176A can be set up to output NTSC, PAL (B, D, G, H, I) and PAL (M) standard video.

Pedestal Control (MR02)

This bit specifies whether a pedestal is to be generated on the NTSC composite video signal. This bit is invalid if the ADV7175A/ADV7176A is configured in PAL mode.

Luminance Filter Control (MR04–MR03)

The luminance filters are divided into two sets (NTSC/PAL) of four filters, low-pass A, low-pass B, notch and extended. When PAL is selected, bits MR03 and MR04 select one of four PAL luminance filters; likewise, when NTSC is selected, bits MR03 and MR04 select one of four NTSC luminance filters. The filters are illustrated in Figures 4 to 12.

RGB Sync (MR05)

This bit is used to set up the RGB outputs with the sync information encoded on all RGB outputs.

Output Control (MR06)

This bit specifies if the part is in composite video or RGB/YUV mode. Please note that the main composite signal is still available in RGB/YUV mode.

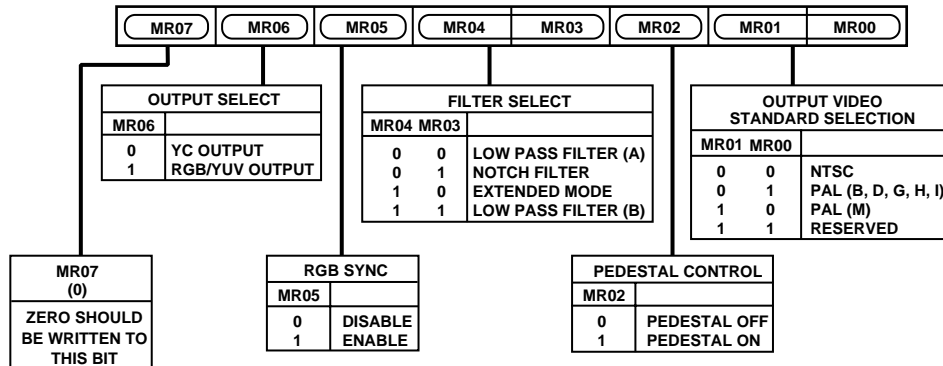

Figure 32. Mode Register 0 (MR0)

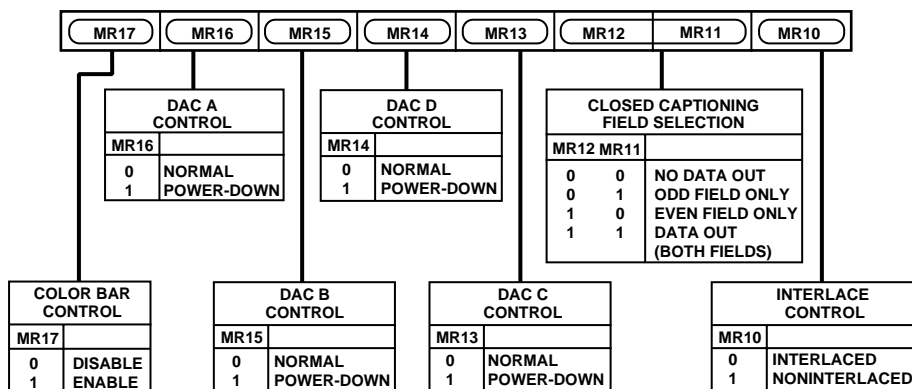

Figure 33. Mode Register 1 (MR1)

ADV7175A/ADV7176A

MODE REGISTER 1 MR1 (MR17–MR10)

(Address [SR4–SR0] = 01H)

Figure 33 shows the various operations under the control of Mode Register 1. This register can be read from as well as written to.

MR1 BIT DESCRIPTION

Interlaced Mode Control (MR10)

This bit is used to set up the output to interlaced or noninterlaced mode. This mode is only relevant when the part is in composite video mode.

Closed Captioning Field Control (MR12–MR11)

These bits control the fields on which closed captioning data is displayed; closed captioning information can be displayed on an odd field, even field or both fields.

DAC Control (MR16–MR13)

These bits can be used to power down the DACs. This can be used to reduce the power consumption of the ADV7175A/ADV7176A if any of the DACs are not required in the application.

Color Bar Control (MR17)

This bit can be used to generate and output an internal color bar test pattern. The color bar configuration is 75/7.5/75/7.5 for NTSC and 100/0/75/0 for PAL. It is important to note that when color bars are enabled the ADV7175A/ADV7176A is configured in a master timing mode as per the one selected by bits TR01 and TR02.

SUBCARRIER FREQUENCY REGISTER 3-0 (FSC3–FSC0)

(Address [SR4–SR0] = 05H–02H)

These 8-bit wide registers are used to set up the subcarrier frequency. The value of these registers are calculated by using the following equation:

$$\text{Subcarrier Frequency Register} = \frac{2^{32} - 1}{F_{CLK}} \times F_{SCF}$$

i.e.: NTSC Mode,

$$F_{CLK} = 27 \text{ MHz,}$$

$$F_{SCF} = 3.5795454 \text{ MHz}$$

$$\begin{aligned} \text{Subcarrier Frequency Value} &= \frac{2^{32} - 1}{27 \times 10^6} \times 3.5795454 \times 10^6 \\ &= 21F07C16 \text{ HEX} \end{aligned}$$

Figure 34 shows how the frequency is set up by the four registers.

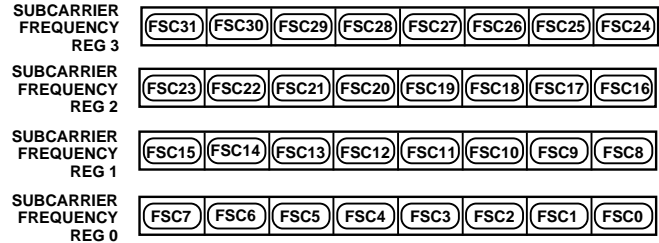

Figure 34. Subcarrier Frequency Register

SUBCARRIER PHASE REGISTER (FP7–FP0)

(Address [SR4–SR0] = 06H)

This 8-bit wide register is used to set up the subcarrier phase. Each bit represents 1.41°.

TIMING REGISTER 0 (TR07–TR00)

(Address [SR4–SR0] = 07H)

Figure 35 shows the various operations under the control of Timing Register 0. This register can be read from as well as written to. This register can be used to adjust the width and position of the master mode timing signals.

TR0 BIT DESCRIPTION

Master/Slave Control (TR00)

This bit controls whether the ADV7175A/ADV7176A is in master or slave mode.

Timing Mode Control (TR02–TR01)

These bits control the timing mode of the ADV7175A/ADV7176A. These modes are described in the Timing and Control section of the data sheet.

BLANK Control (TR03)

This bit controls whether the $\overline{\text{BLANK}}$ input is used when the part is in slave mode.

Luma Delay Control (TR05–TR04)

These bits control the addition of a luminance delay. Each bit represents a delay of 74 ns.

Pixel Port Select (TR06)

This bit is used to set the pixel port to accept 8-bit or 16-bit data. If an 8-bit input is selected the data will be set up on Pins P7–P0.

Timing Register Reset (TR07)

Toggling TR07 from low to high and low again resets the internal timing counters. This bit should be toggled after power-up, reset or changing to a new timing mode.

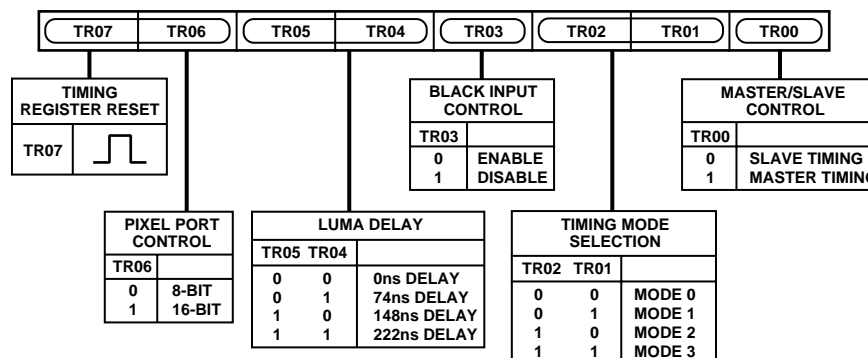

Figure 35. Timing Register 0

**CLOSED CAPTIONING EVEN FIELD
DATA REGISTER 1-0 (CED15-CED00)**
(Address [SR4-SR0] = 09-08H)

These 8-bit wide registers are used to set up the closed captioning extended data bytes on even fields. Figure 36 shows how the high and low bytes are set up in the registers.



Figure 36. Closed Captioning Extended Data Register

**CLOSED CAPTIONING ODD FIELD
DATA REGISTER 1-0 (CCD15-CCD00)**
(Subaddress [SR4-SR0] = 0B-0AH)

These 8-bit wide registers are used to set up the closed captioning data bytes on odd fields. Figure 37 shows how the high and low bytes are set up in the registers.

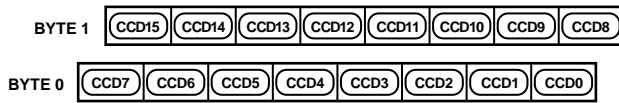

Figure 37. Closed Captioning Data Register

TIMING REGISTER 1 (TR17-TR10)
(ADDRESS [SR4-SR0] = 0CH)

Timing Register 1 is an 8-Bit Wide Register

Figure 38 shows the various operations under the control of Timing Register 1. This register can be read from as well as written to. This register can be used to adjust the width and position of the master mode timing signals.

TR1 BIT DESCRIPTION

HSYNC Width (TR11-TR10)

These bits adjust the HSYNC pulsewidth.

HSYNC to VSYNC/FIELD Delay Control (TR13-TR12)

These bits adjust the position of the HSYNC output relative to the FIELD/VSYNC output.

HSYNC to FIELD Delay Control (TR15-TR14)

When the ADV7175A/ADV7176A is in Timing Mode 1, these bits adjust the position of the HSYNC output relative to the FIELD output rising edge.

VSYNC Width (TR15-TR14)

When the ADV7175A/ADV7176A is in Timing Mode 2, these bits adjust the VSYNC pulsewidth.

HSYNC to Pixel Data Adjust (TR17-TR16)

This enables the HSYNC to be adjusted with respect to the pixel data. This allows the Cr and Cb components to be swapped. This adjustment is available in both master and slave timing modes.

MODE REGISTER 2 MR2 (MR27-MR20)

(Address [SR4-SR0] = 0DH)

Mode Register 2 is an 8-bit wide register.

Figure 39 shows the various operations under the control of Mode Register 2. This register can be read from as well as written to.

MR2 BIT DESCRIPTION

Square Pixel Mode Control (MR20)

This bit is used to set up square pixel mode. This is available in slave mode only. For NTSC, a 24.54 MHz clock must be supplied. For PAL, a 29.5 MHz clock must be supplied.

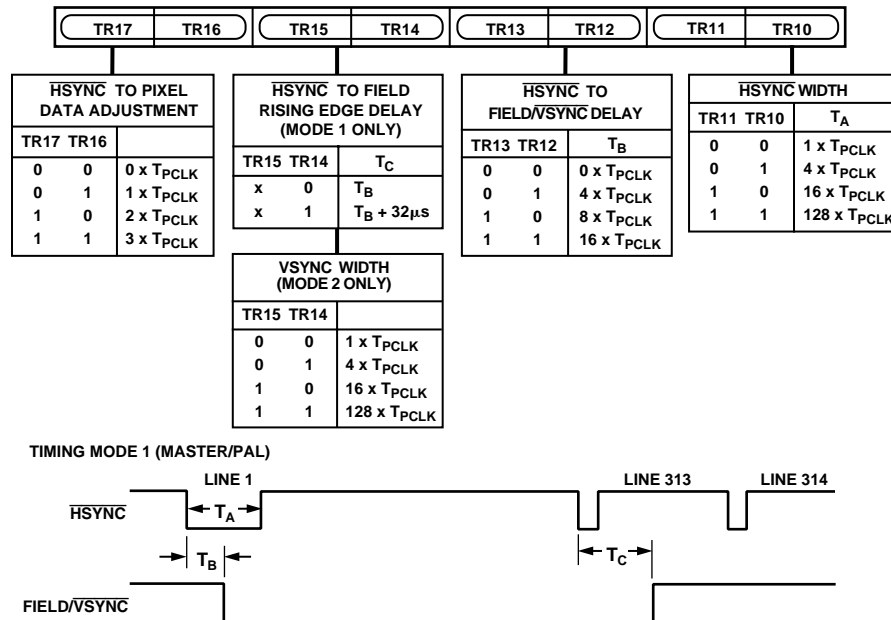

Figure 38. Timing Register 1

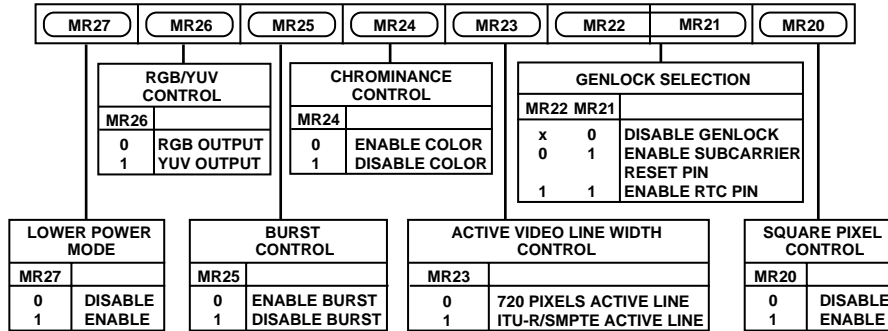

Figure 39. Mode Register 2

Genlock Control (MR22–MR21)

These bits control the genlock feature of the ADV7175A/ADV7176A. Setting MR21 to a Logic “1” configures the SCRESET/RTC pin as an input. Setting MR22 to Logic Level “0” configures the SCRESET/RTC pin as a subcarrier reset input, therefore, the subcarrier will reset to Field 0, following a high-to-low transition on the SCRESET/RTC pin. Setting MR22 to Logic Level “1” configures the SCRESET/RTC pin as a real-time control input.

Active Video Line Control (MR23)

This bit switches between two active video line durations. A zero selects ITU-R BT.470 (720 pixels PAL/NTSC) and a one selects ITU-R/SMPTE “analog” standard for active video duration (710 pixels NTSC 702 pixels PAL).

Chrominance Control (MR24)

This bit enables the color information to be switched on and off the video output.

Burst Control (MR25)

This bit enables the burst information to be switched on and off the video output.

RGB/YUV Control (MR26)

This bit enables the output from the RGB DACs to be set to YUV output video standard. Bit MR06 of Mode Register 0 must be set to Logic Level “1” before MR26 is set.

Lower Power Control (MR27)

This bit enables the lower power mode of the ADV7175A/ADV7176A. This will reduce the DAC current by 50%.

NTSC PEDESTAL/PAL TELETEXT CONTROL REGISTERS 3–0 (PCE15–0, PCO15–0) (TXE15–0, TXO15–0) (Subaddress [SR4–SR0] = 11–0EH)

These 8-bit wide registers are used to set up the NTSC pedestal/PAL teletext on a line-by-line basis in the vertical blanking interval for both odd and even fields. Figures 40 and 41 show the four control registers. A Logic “1” in any of the bits of these registers has the effect of turning the pedestal OFF on the equivalent line when used in NTSC. A Logic “1” in any of the bits of these registers has the effect of turning teletext ON the equivalent line when used in PAL.

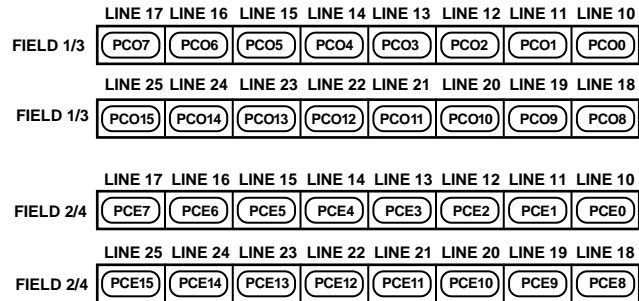

Figure 40. Pedestal Control Registers

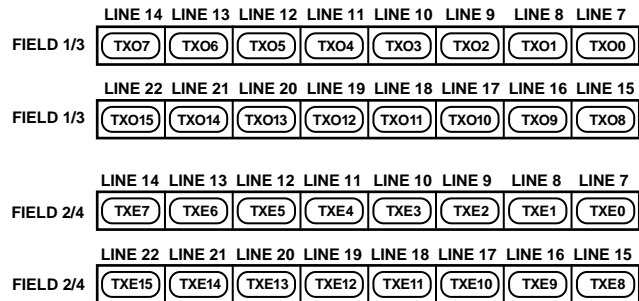

Figure 41. Teletext Control Registers

MODE REGISTER 3 MR3 (MR37–MR30) (Address [SR4–SR0] = 12H)

Mode Register 3 is an 8-bit wide register.

Figure 42 shows the various operations under the control of Mode Register 3.

MR3 BIT DESCRIPTION

Revision Code (MR30)

This bit is read only and indicates the revision of the device.

VBI Pass-Through Control (MR31)

This bit determines whether or not data in the vertical blanking interval (VBI) is output to the analog outputs or blanked.

Reserved (MR33–MR32)

These bits are reserved.

Teletext Enable (MR34)

This bit must be set to “1” to enable teletext data insertion on the TTX pin.

Input Default Color (MR36)

This bit determines the default output color from the DACs for zero input data (or disconnected). A Logical “0” means that the color corresponding to 00000000 will be displayed. A Logical “1” forces the output color to black for 00000000 input video data.

DAC Switching Control (MR37)

This bit is used to switch the DAC outputs from SCART to a EUROSCART configuration. A complete table of all DAC output configurations is shown below.

Table I. DAC Output Configuration Matrix

| MR06 | MR26 | MR37 | DAC A | DAC B | DAC C | DAC D | Simultaneous Output |
|------|------|------|-------|-------|-------|-------|---------------------|
| 0 | 0 | 0 | CVBS | CVBS | C | Y | 2 Composite and Y/C |
| 0 | 0 | 1 | Y | CVBS | C | CVBS | 2 Composite and Y/C |
| 0 | 1 | 0 | CVBS | CVBS | C | Y | 2 Composite and Y/C |
| 0 | 1 | 1 | Y | CVBS | C | CVBS | 2 Composite and Y/C |
| 1 | 0 | 0 | CVBS | B | R | G | RGB and Composite |
| 1 | 0 | 1 | G | B | R | CVBS | RGB and Composite |
| 1 | 1 | 0 | CVBS | U | V | Y | YUV and Composite |
| 1 | 1 | 1 | Y | U | V | CVBS | YUV and Composite |

CVBS: Composite Video Baseband Signal
 Y: Luminance Component Signal (For YUV or Y/C Mode)
 C: Chrominance Signal (For Y/C Mode)
 U: Chrominance Component Signal (For YUV Mode)
 V: Chrominance Component Signal (For YUV Mode)
 R: RED Component Video (For RGB Mode)
 G: GREEN Component Video (For RGB Mode)
 B: BLUE Component Video (For RGB Mode)

NOTE
 Each DAC can be individually powered ON or OFF with the following control bits (“0” = ON, “1” = OFF):
 MR13 - DAC C
 MR14 - DAC D
 MR15 - DAC B
 MR16 - DAC A

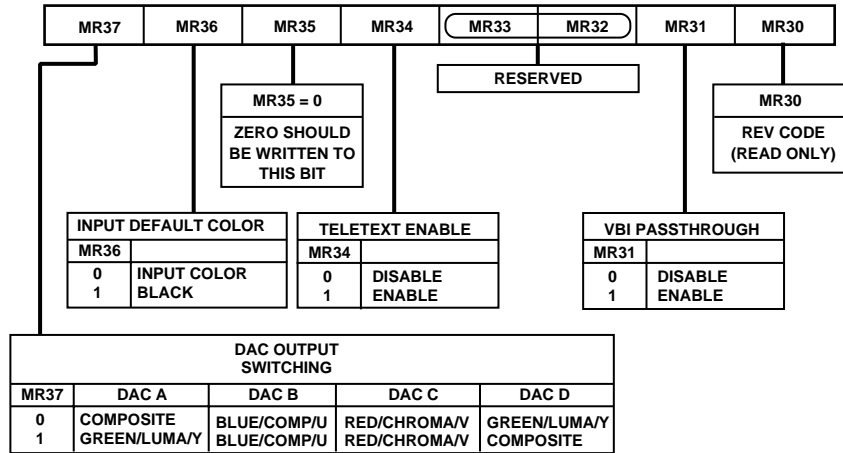

Figure 42. Mode Register 3

TELETEXT CONTROL REGISTER TC07 (TC07–TC00) (Address [SR4–SR0] = 24H)

Teletext Control Register is an 8-bit wide register.

TTXREQ Rising Edge Control (TC07–TC04)

These bits control the position of the rising edge of TTXREQ. It can be programmed from zero CLOCK cycles to a max of 15 CLOCK cycles—see Figure 48.

TTXREQ Falling Edge Control (TC03–TC00)

These bits control the position of the falling edge of TTXREQ. It can be programmed from zero CLOCK cycles to a max of 15 CLOCK cycles. This controls the active window for teletext data. Increasing this value reduces the amount of teletext bits below the default of 360. If bits TC03–TC00 are unchanged

when bits TC07–TC04 are changed, the falling edge of TTXREQ will track that of the rising edge (i.e., the time between the falling and rising edge remains constant)—see Figure 48.

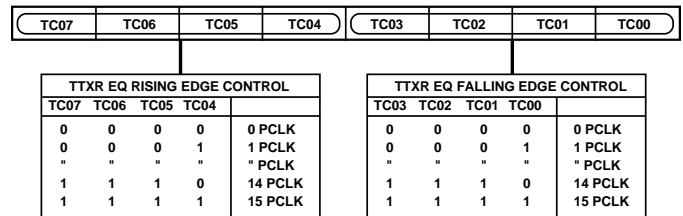

Figure 43. Teletext Control Register

ADV7175A/ADV7176A

APPENDIX 1

BOARD DESIGN AND LAYOUT CONSIDERATIONS

The ADV7175A/ADV7176A is a highly integrated circuit containing both precision analog and high speed digital circuitry. It has been designed to minimize interference effects on the integrity of the analog circuitry by the high speed digital circuitry. It is imperative that these same design and layout techniques be applied to the system level design so that high speed, accurate performance is achieved. The “Recommended Analog Circuit Layout” shows the analog interface between the device and monitor.

The layout should be optimized for lowest noise on the ADV7175A/ADV7176A power and ground lines by shielding the digital inputs and providing good decoupling. The lead length between groups of V_{AA} and GND pins should be minimized to minimize inductive ringing.

Ground Planes

The ground plane should encompass all ADV7175A/ADV7176A ground pins, voltage reference circuitry, power supply bypass circuitry for the ADV7175A/ADV7176A, the analog output traces, and all the digital signal traces leading up to the ADV7175A/ADV7176A. The ground plane is the board's common ground plane.

This should be as substantial as possible to maximize heat spreading and power dissipation on the board.

Power Planes

The ADV7175A/ADV7176A and any associated analog circuitry should have its own power plane, referred to as the analog power plane (V_{AA}). This power plane should be connected to the regular PCB power plane (V_{CC}) at a single point through a ferrite bead. This bead should be located within three inches of the ADV7175A/ADV7176A.

The metallization gap separating device power plane and board power plane should be as narrow as possible to minimize the obstruction to the flow of heat from the device into the general board.

The PCB power plane should provide power to all digital logic on the PC board, and the analog power plane should provide power to all ADV7175A/ADV7176A power pins and voltage reference circuitry.

Plane-to-plane noise coupling can be reduced by ensuring that portions of the regular PCB power and ground planes do not overlay portions of the analog power plane unless they can be arranged so that the plane-to-plane noise is common-mode.

Supply Decoupling

For optimum performance, bypass capacitors should be installed using the shortest leads possible, consistent with reliable operation, to reduce the lead inductance. Best performance is obtained with 0.1 μ F ceramic capacitor decoupling. Each group of V_{AA} pins on the ADV7175A/ADV7176A must have at least one 0.1 μ F decoupling capacitor to GND. These capacitors should be placed as close to the device as possible.

It is important to note that while the ADV7175A/ADV7176A contains circuitry to reject power supply noise, this rejection decreases with frequency. If a high frequency switching power supply is used, the designer should pay close attention to reducing power supply noise and consider using a three terminal voltage regulator for supplying power to the analog power plane.

Digital Signal Interconnect

The digital inputs to the ADV7175A/ADV7176A should be isolated as much as possible from the analog outputs and other analog circuitry. Also, these input signals should not overlay the analog power plane.

Due to the high clock rates involved, long clock lines to the ADV7175A/ADV7176A should be avoided to reduce noise pickup.

Any active termination resistors for the digital inputs should be connected to the regular PCB power plane (V_{CC}) and not the analog power plane.

Analog Signal Interconnect

The ADV7175A/ADV7176A should be located as close to the output connectors as possible to minimize noise pickup and reflections due to impedance mismatch.

The video output signals should overlay the ground plane, not the analog power plane, to maximize the high frequency power supply rejection.

Digital inputs, especially pixel data inputs and clocking signals, should never overlay any of the analog signal circuitry and should be kept as far away as possible.

For best performance, the outputs should each have a 75 Ω load resistor connected to GND. These resistors should be placed as close as possible to the ADV7175A/ADV7176A as to minimize reflections.

The ADV7175A/ADV7176A should have no inputs left floating. Any inputs that are not required should be tied to ground.

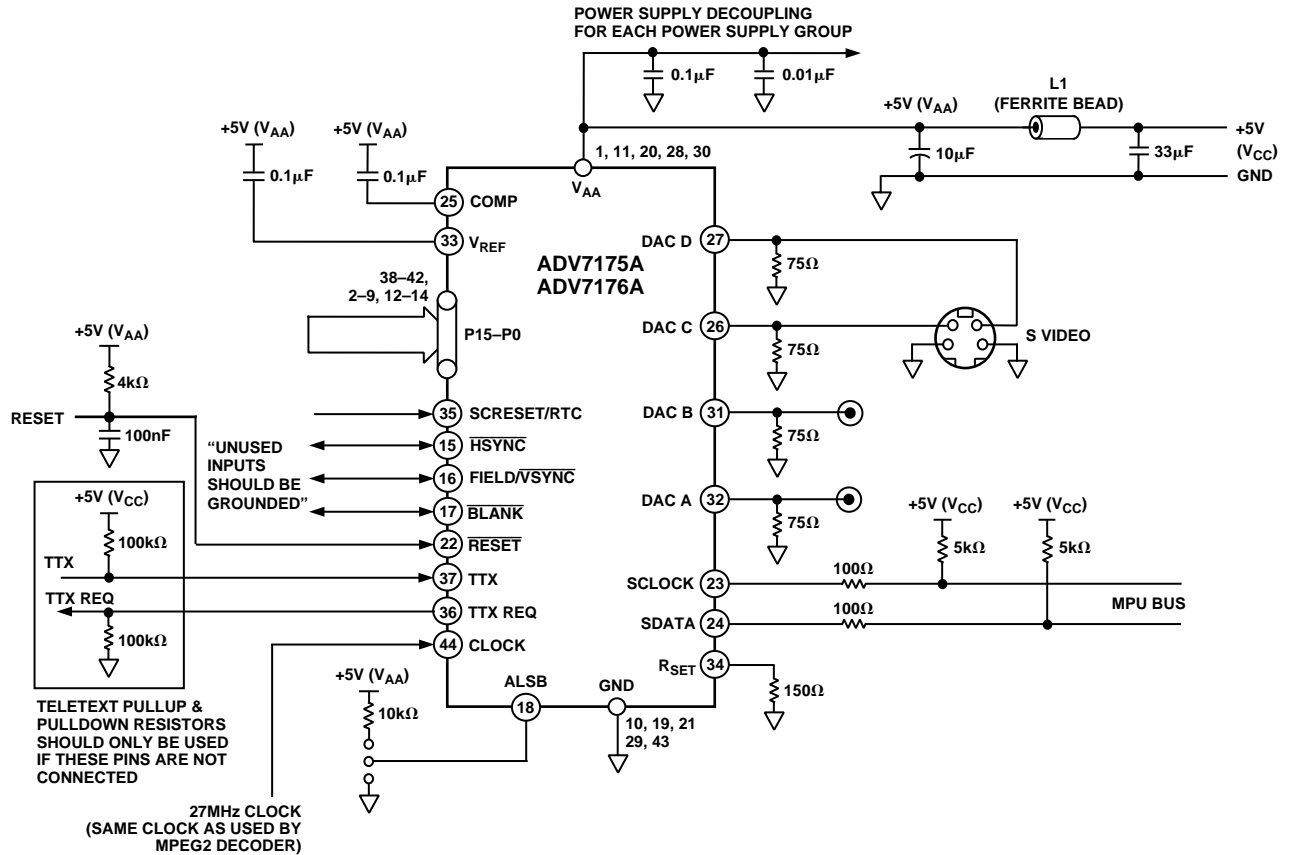

Figure 44. Recommended Analog Circuit Layout

The circuit below can be used to generate a 13.5 MHz waveform using the 27 MHz clock and the $\overline{\text{HSYNC}}$ pulse. This waveform is guaranteed to produce the 13.5 MHz clock in synchronization with the 27 MHz clock. This 13.5 MHz clock can be used if the 13.5 MHz clock is required by the MPEG decoder. This will guarantee that the Cr and Cb pixel information is input to the ADV7175A/ADV7176A in the correct sequence.

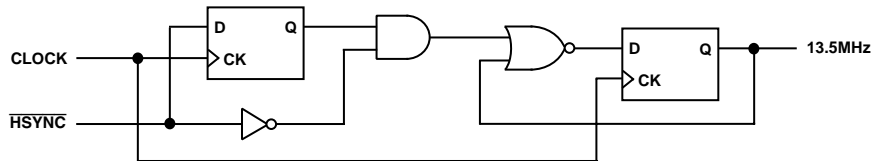

Figure 45. Circuit to Generate 13.5 MHz

APPENDIX 2

CLOSED CAPTIONING

The ADV7175A/ADV7176A supports closed captioning, conforming to the standard television synchronizing waveform for color transmission. Closed captioning is transmitted during the blanked active line time of Line 21 of the odd fields and Line 284 of even fields.

Closed captioning consists of a 7-cycle sinusoidal burst that is frequency and phase locked to the caption data. After the clock run-in signal, the blanking level is held for two data bits and is followed by a Logic Level "1" start bit. 16 bits of data follow the start bit. These consist of two 8-bit bytes, seven data bits and one odd parity bit. The data for these bytes is stored in closed captioning Data Registers 0 and 1.

The ADV7175A/ADV7176A also supports the extended closed captioning operation, which is active during even fields, and is encoded on scan Line 284. The data for this operation is stored in closed captioning extended Data Registers 0 and 1.

All clock run-in signals and timing to support closed captioning on Lines 21 and 284 are generated automatically by the ADV7175A/ADV7176A. All pixels inputs are ignored during Lines 21 and 284.

FCC Code of Federal Regulations (CFR) 47 Section 15.119 and EIA608 describe the closed captioning information for Lines 21 and 284.

The ADV7175A/ADV7176A uses a single buffering method. This means that the closed captioning buffer is only one byte deep, therefore there will be no frame delay in outputting the closed captioning data unlike other 2-byte deep buffering systems. The data must be loaded at least one line before (Line 20 or Line 283) it is outputted on Line 21 and Line 284. A typical implementation of this method is to use $\overline{\text{VSYNC}}$ to interrupt a microprocessor, which will in turn load the new data (two bytes) every field. If no new data is required for transmission you must insert zeros in both the data registers; this is called NULLING. It is also important to load "control codes," all of which are double bytes on Line 21, or a TV will not recognize them. If you have a message like "Hello World" which has an odd number of characters, it is important to pad it out to an even number to get "end of caption" 2-byte control code to land in the same field.

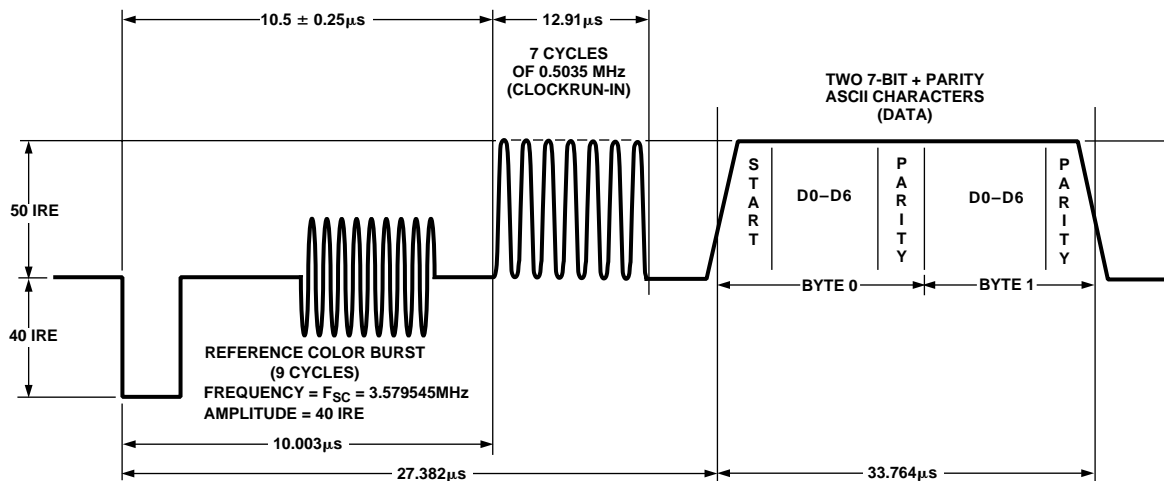

Figure 46. Closed Captioning Waveform (NTSC)

APPENDIX 3

TELETEXT INSERTION

Time T_{PD} time needed by the ADV7175A/ADV7176A to interpolate input data on TTX and insert it onto the CVBS or Y outputs, such that it appears $T_{synTtxtOut} = 10.2 \mu s$ after the leading edge of the horizontal signal. Time T_{txtDel} is the pipeline delay time by the source that is gated by the $TXTREQ$ signal in order to deliver TTX data.

With the programmability that is offered with $TXTREQ$ signal on the Rising/Falling edges, the TTX data is always inserted at the correct position of $10.2 \mu s$ after the leading edge of Horizontal Sync pulse, which enables a source interface with variable pipeline delays.

The width of the $TXTREQ$ signal must always be maintained so it allows the insertion of 360 (to comply with the Teletext Standard "PAL-WST") teletext bits at a text data rate of 6.9375 Mbits/s; this is achieved by setting $TC03$ - $TC00$ to zero. The insertion window is not open if the Teletext Enable bit ($MR34$) is set to zero.

Teletext Protocol

The relationship between the TTX bit clock (6.9375 MHz) and the system $CLOCK$ (27 MHz) for 50 Hz is given as follows:

$$\left(\frac{27 \text{ MHz}}{4} \right) = 6.75 \text{ MHz}$$

$$\left(\frac{6.9375 \times 10^6}{6.75 \times 10^6} \right) = 1.027777$$

Thus 37 TTX bits correspond to 144 clocks (27 MHz) and each bit has a width of almost four clock cycles. The ADV7175A/ADV7176A uses an internal sequencer and variable phase interpolation filter to minimize the phase jitter and thus generate a bandlimited signal which can be outputted on the CVBS and Y outputs.

At the TTX input the bit duration scheme repeats after every 37 TTX bits or 144 clock cycles. The protocol requires that TTX bits 10, 19, 28, 37 are carried by three clock cycles, all other bits by four clock cycles. After 37 TTX bits, the next bits with three clock cycles are 47, 56, 65 and 74. This scheme holds for all following cycles of 37 TTX bits, until all 360 TTX bits are completed. All teletext lines are implemented in the same way. Individual control of teletext lines are controlled by Teletext Setup Registers.

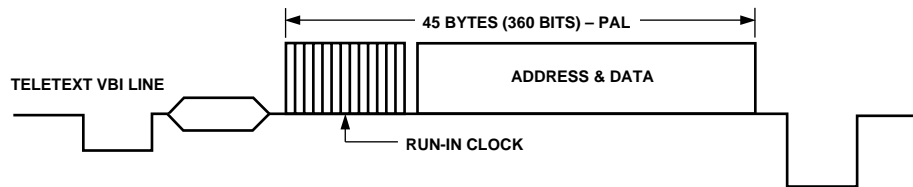

Figure 47. Teletext VBI Line

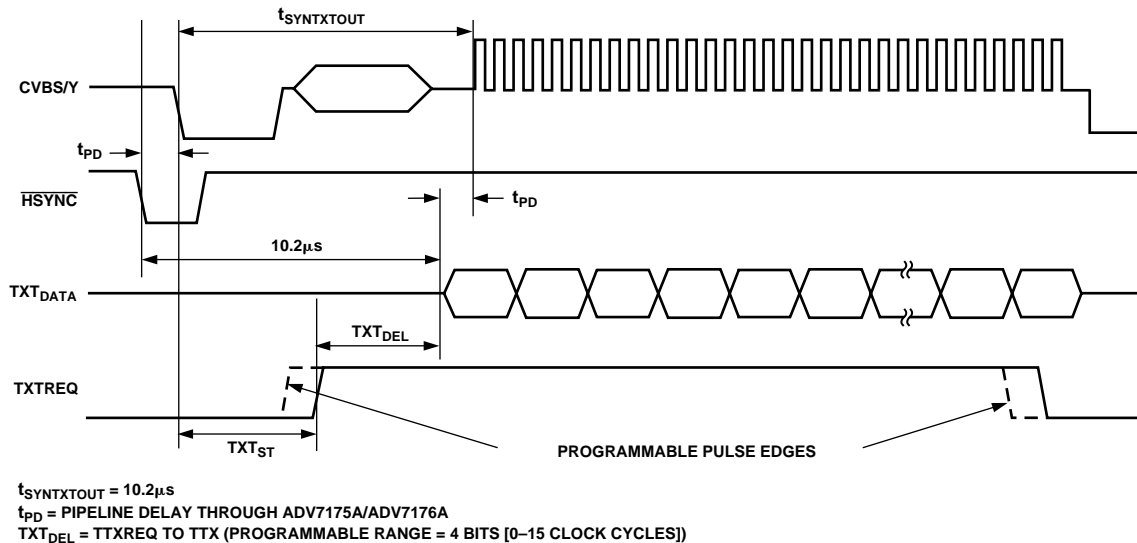

Figure 48. Teletext Functionality Diagram

APPENDIX 4

NTSC WAVEFORMS (WITH PEDESTAL)

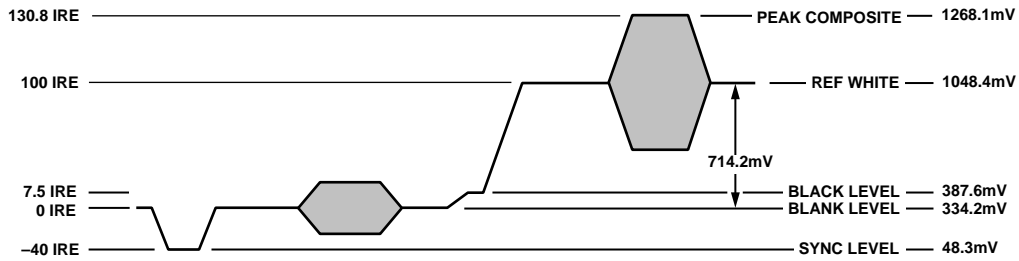

Figure 49. NTSC Composite Video Levels

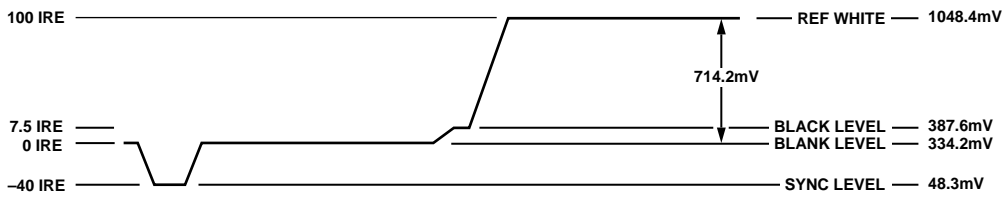

Figure 50. NTSC Luma Video Levels

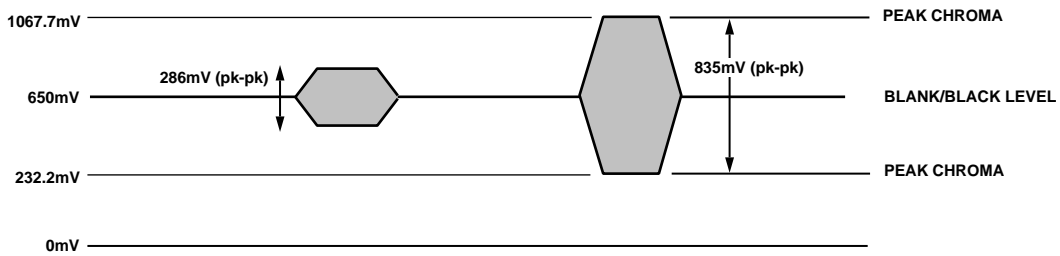

Figure 51. NTSC Chroma Video Levels

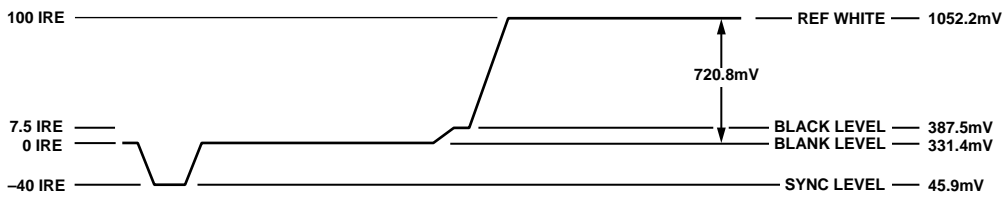

Figure 52. NTSC RGB Video Levels

NTSC WAVEFORMS (WITHOUT PEDESTAL)

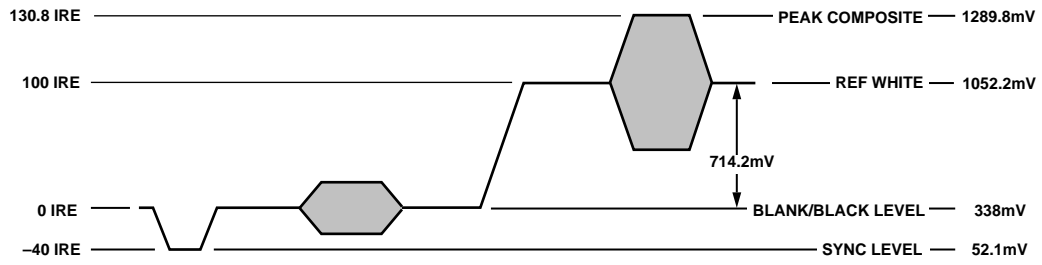

Figure 53. NTSC Composite Video Levels

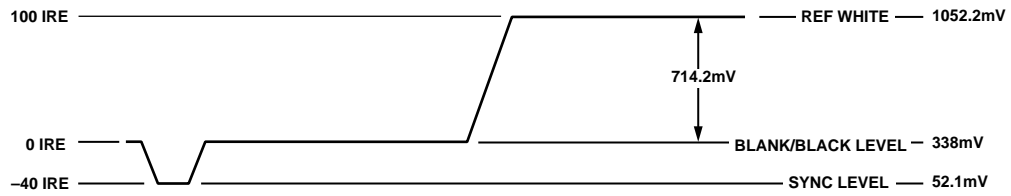

Figure 54. NTSC Luma Video Levels

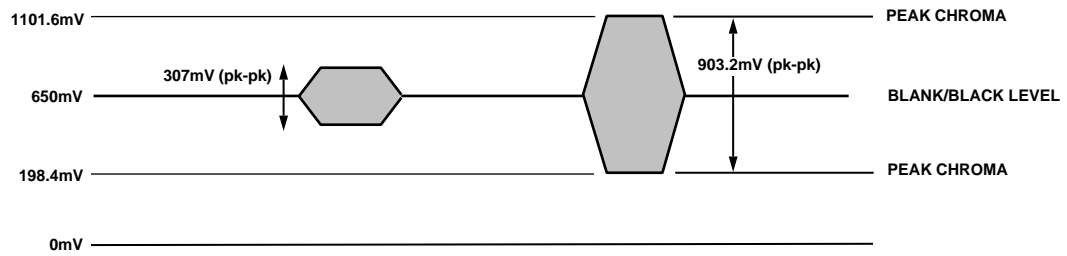

Figure 55. NTSC Chroma Video Levels

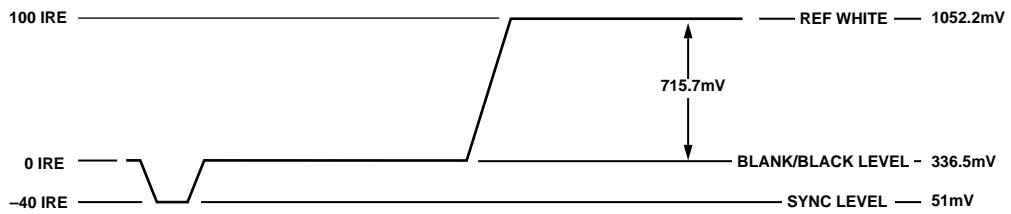

Figure 56. NTSC RGB Video Levels

PAL WAVEFORMS

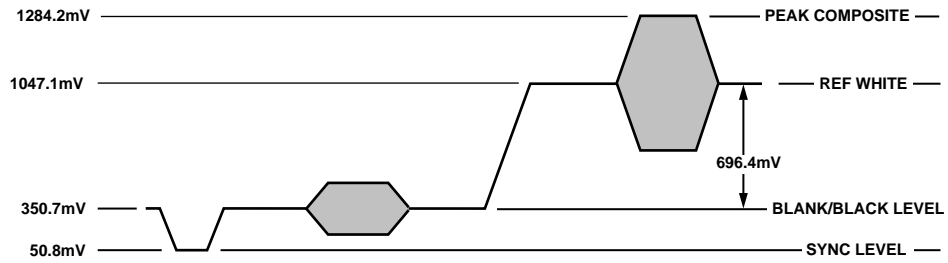

Figure 57. PAL Composite Video Levels

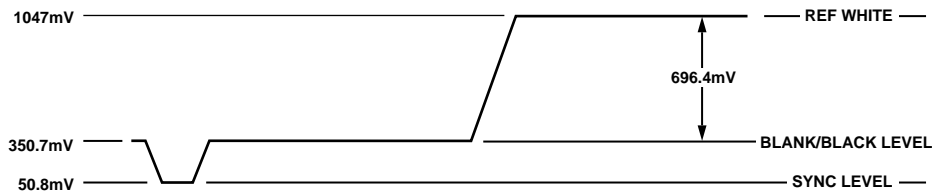

Figure 58. PAL Luma Video Levels

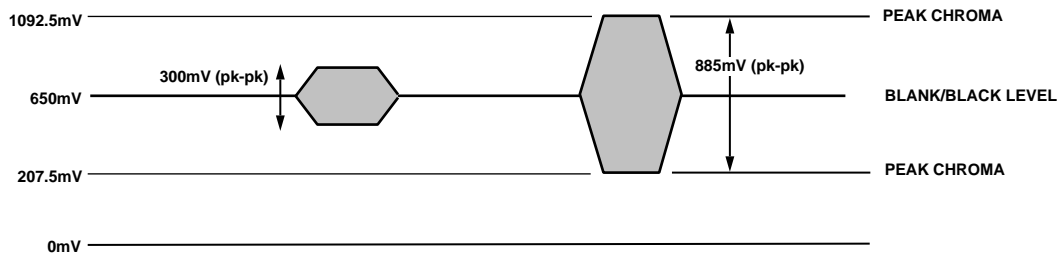

Figure 59. PAL Chroma Video Levels

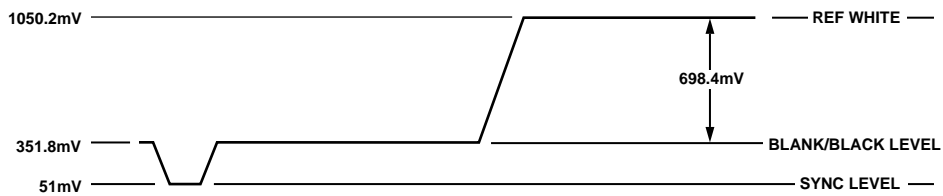

Figure 60. PAL RGB Video Levels

UV WAVEFORMS

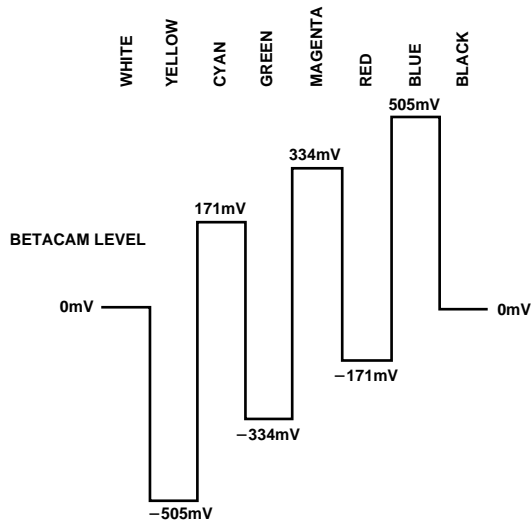

Figure 61. NTSC 100% Color Bars No Pedestal U Levels

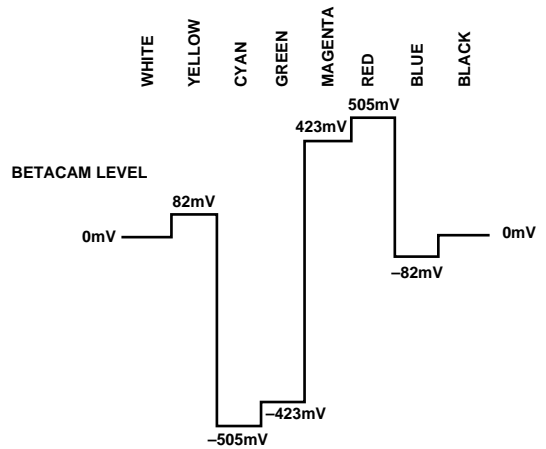

Figure 64. NTSC 100% Color Bars No Pedestal V Levels

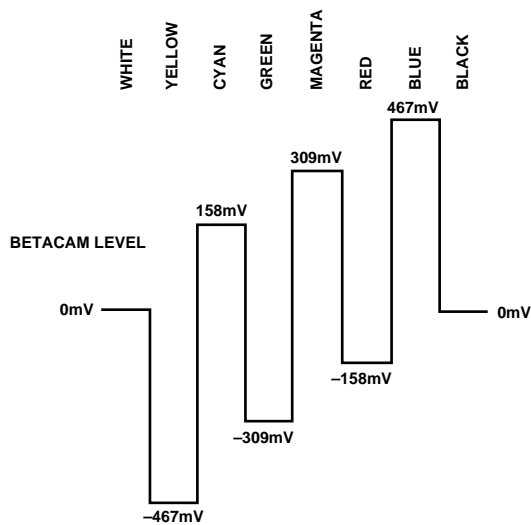

Figure 62. NTSC 100% Color Bars with Pedestal U Levels

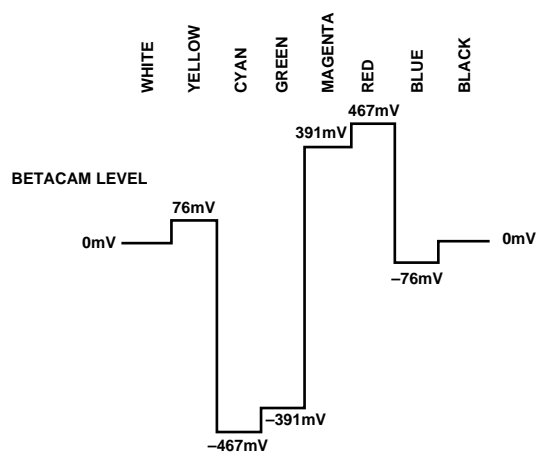

Figure 65. NTSC 100% Color Bars with Pedestal V Levels

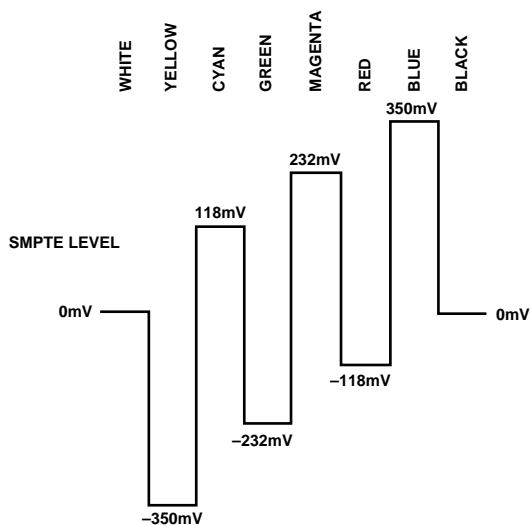

Figure 63. PAL 1005 Color Bars U Levels

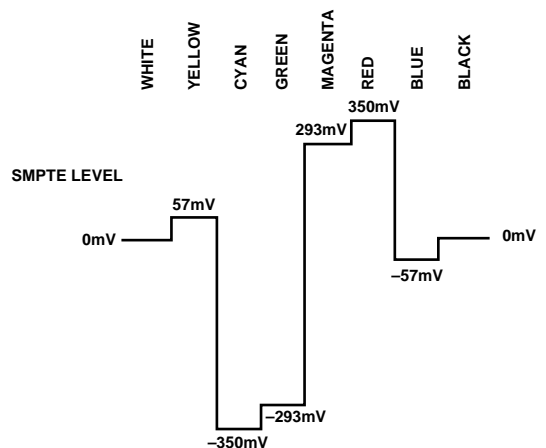

Figure 66. PAL 100% Color Bars V Levels

ADV7175A/ADV7176A

APPENDIX 5

REGISTER VALUES

The ADV7175A/ADV7176A registers can be set depending on the user standard required.

The following examples give the various register formats for several video standards.

In each case the output is set to composite o/p with all DACs powered up and with the BLANK input control disabled. Additionally, the burst and color information are enabled on the output and the internal color bar generator is switched off. In the examples shown, the timing mode is set to Mode 0 in slave format. TR02–TR00 of the Timing Register 0 control the timing modes. For a detailed explanation of each bit in the command registers, please turn to the Register Programming section of the data sheet. TR07 should be toggled after setting up a new timing mode. Timing Register 1 provides additional control over the position and duration of the timing signals. In the examples, this register is programmed in default mode.

NTSC ($F_{SC} = 3.5795454$ MHz)

| Address | Data |
|---------|----------------------------------|
| 00Hex | Mode Register 0 |
| 01Hex | Mode Register 1 |
| 02Hex | Subcarrier Frequency Register 0 |
| 03Hex | Subcarrier Frequency Register 1 |
| 04Hex | Subcarrier Frequency Register 2 |
| 05Hex | Subcarrier Frequency Register 3 |
| 06Hex | Subcarrier Phase Register |
| 07Hex | Timing Register 0 |
| 08Hex | Closed Captioning Ext Register 0 |
| 09Hex | Closed Captioning Ext Register 1 |
| 0AHex | Closed Captioning Register 0 |
| 0BHex | Closed Captioning Register 1 |
| 0CHex | Timing Register 1 |
| 0DHex | Mode Register 2 |
| 0EHex | Pedestal Control Register 0 |
| 0FHex | Pedestal Control Register 1 |
| 10Hex | Pedestal Control Register 2 |
| 11Hex | Pedestal Control Register 3 |
| 12Hex | Mode Register 3 |
| 24Hex | Teletext Control Register |

PAL B, D, G, H, I ($F_{SC} = 4.43361875$ MHz)

| Address | Data |
|---------|----------------------------------|
| 00Hex | Mode Register 0 |
| 01Hex | Mode Register 1 |
| 02Hex | Subcarrier Frequency Register 0 |
| 03Hex | Subcarrier Frequency Register 1 |
| 04Hex | Subcarrier Frequency Register 2 |
| 05Hex | Subcarrier Frequency Register 3 |
| 06Hex | Subcarrier Phase Register |
| 07Hex | Timing Register 0 |
| 08Hex | Closed Captioning Ext Register 0 |
| 09Hex | Closed Captioning Ext Register 1 |
| 0AHex | Closed Captioning Register 0 |
| 0BHex | Closed Captioning Register 1 |
| 0CHex | Timing Register 1 |
| 0DHex | Mode Register 2 |
| 0EHex | Pedestal Control Register 0 |
| 0FHex | Pedestal Control Register 1 |

| Address | Data |
|---------|-----------------------------|
| 10Hex | Pedestal Control Register 2 |
| 11Hex | Pedestal Control Register 3 |
| 12Hex | Mode Register 3 |
| 24Hex | Teletext Control Register |

PAL M ($F_{SC} = 3.57561149$ MHz)

| Address | Data |
|---------|----------------------------------|
| 00Hex | Mode Register 0 |
| 01Hex | Mode Register 1 |
| 02Hex | Subcarrier Frequency Register 0 |
| 03Hex | Subcarrier Frequency Register 1 |
| 04Hex | Subcarrier Frequency Register 2 |
| 05Hex | Subcarrier Frequency Register 3 |
| 06Hex | Subcarrier Phase Register |
| 07Hex | Timing Register 0 |
| 08Hex | Closed Captioning Ext Register 0 |
| 09Hex | Closed Captioning Ext Register 1 |
| 0AHex | Closed Captioning Register 0 |
| 0BHex | Closed Captioning Register 1 |
| 0CHex | Timing Register 1 |
| 0DHex | Mode Register 2 |
| 0EHex | Pedestal Control Register 0 |
| 0FHex | Pedestal Control Register 1 |
| 10Hex | Pedestal Control Register 2 |
| 11Hex | Pedestal Control Register 3 |
| 12Hex | Mode Register 3 |
| 24Hex | Teletext Control Register |

APPENDIX 6

OPTIONAL OUTPUT FILTER

If an output filter is required for the CVBS, Y, UV, Chroma and RGB outputs of the ADV7175A/ADV7176A, the following filter in Figure 67 can be used. Plots of the filter characteristics are shown in Figures 68, 69 and 70. An output filter is not required if the outputs of the ADV7175A/ADV7176A are connected to an analog monitor or an analog TV; however, if the output signals are applied to a system where sampling is used (e.g., digital TV), a filter is required to prevent aliasing.

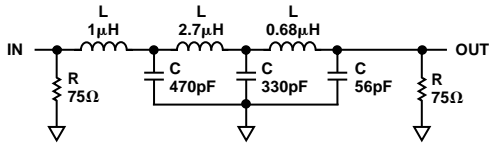

Figure 67. Output Filter

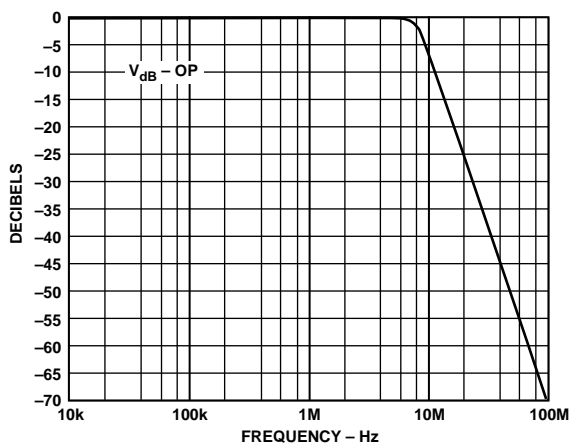

Figure 68. Output Filter Plot

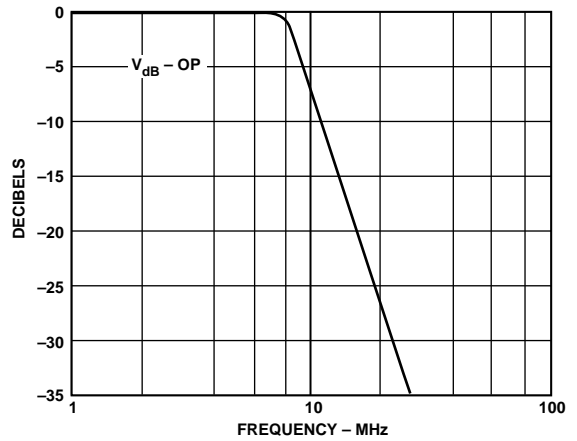

Figure 69. Output Filter Close Up

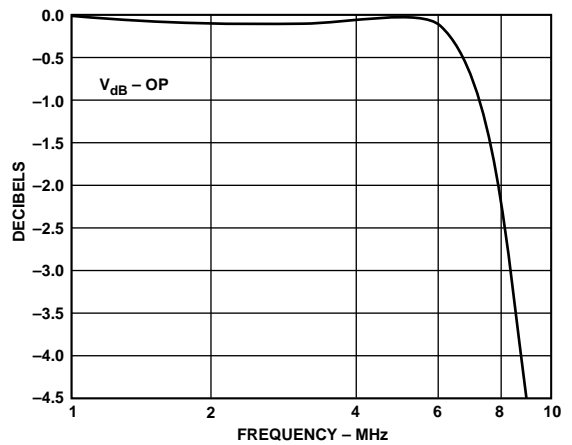

Figure 70. Output Filter Plot Close Up

APPENDIX 7

OPTIONAL DAC BUFFERING

For external buffering of the ADV7175A/ADV7176A DAC outputs, the configuration in Figure 71 is recommended. This configuration shows the DAC outputs running at half (18 mA) their full current (36 mA) capability. This will allow the ADV7175A/ADV7176A to dissipate less power, the analog current is reduced by 50% with a R_{SET} of 300 Ω and a R_{LOAD} of 75 Ω . This mode is recommended for 3.3 volt operation as optimum performance is obtained from the DAC outputs at 18 mA with a V_{AA} of 3.3 volts. This buffer also adds extra isolation on the video outputs, see buffer circuit in Figure 72. When calculating absolute output full current and voltage, use the following equation:

$$V_{OUT} = I_{OUT} \times R_{LOAD}$$

$$I_{OUT} = \frac{(V_{REF} \times K)}{R_{SET}}$$

$$K = 4.2146 \text{ constant, } V_{REF} = 1.235 \text{ V}$$

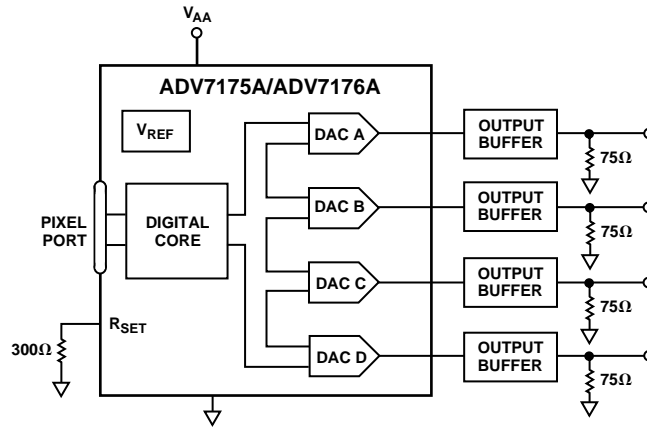

Figure 71. Output DAC Buffering Configuration

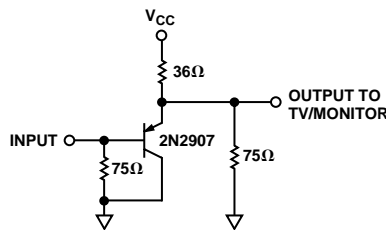

Figure 72. Recommended Output DAC Buffer

APPENDIX 8
OUTPUT WAVEFORMS

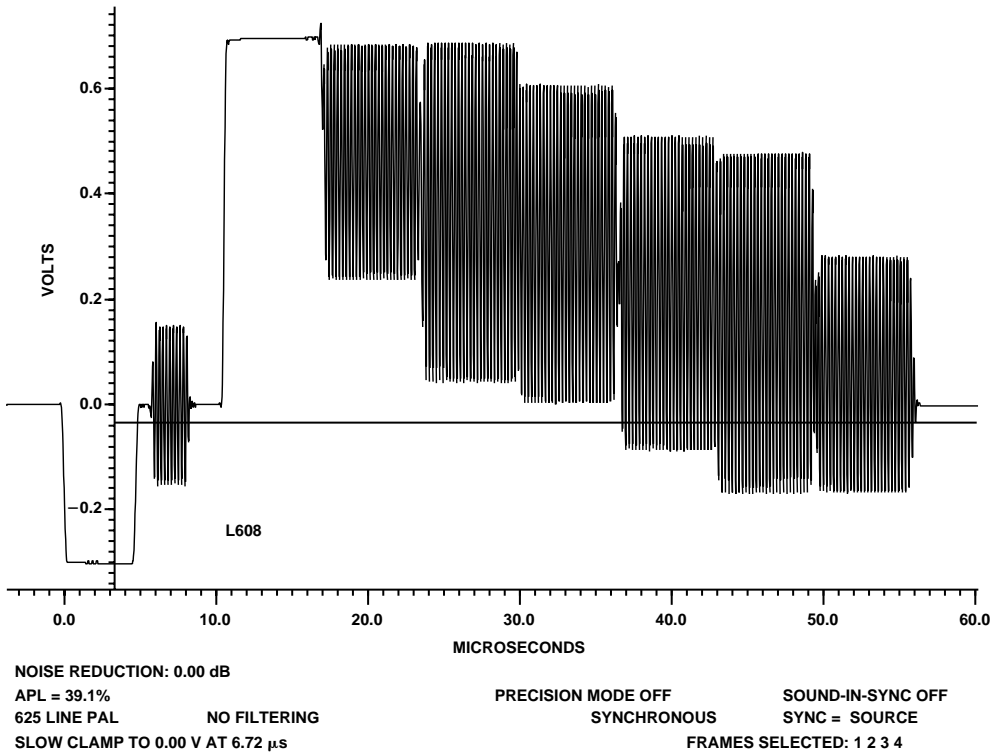

Figure 73. 100/75% PAL Color Bars

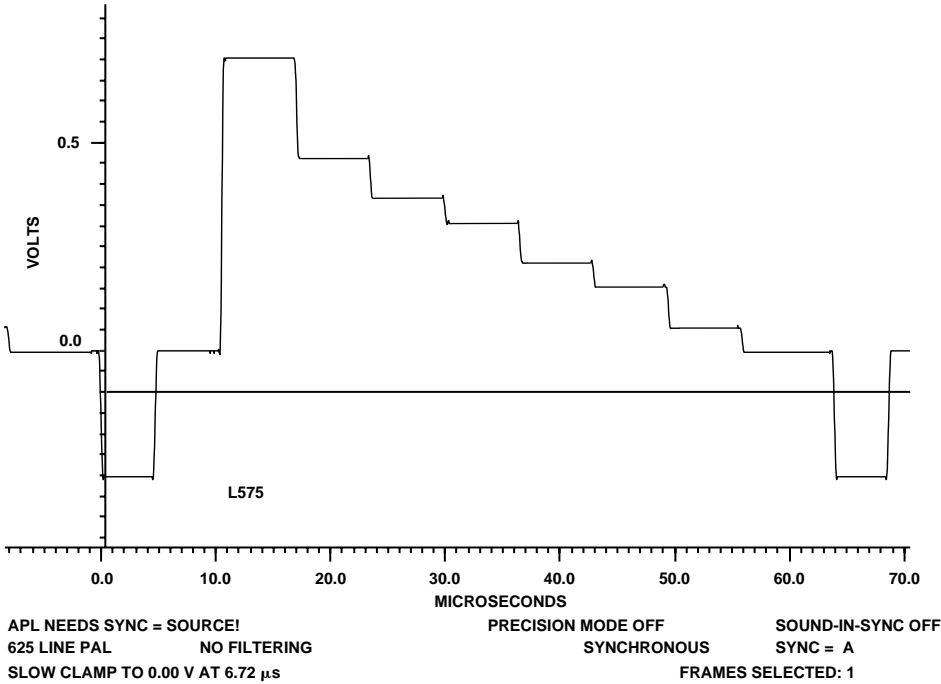

Figure 74. 100/75% PAL Color Bars Luminance

ADV7175A/ADV7176A

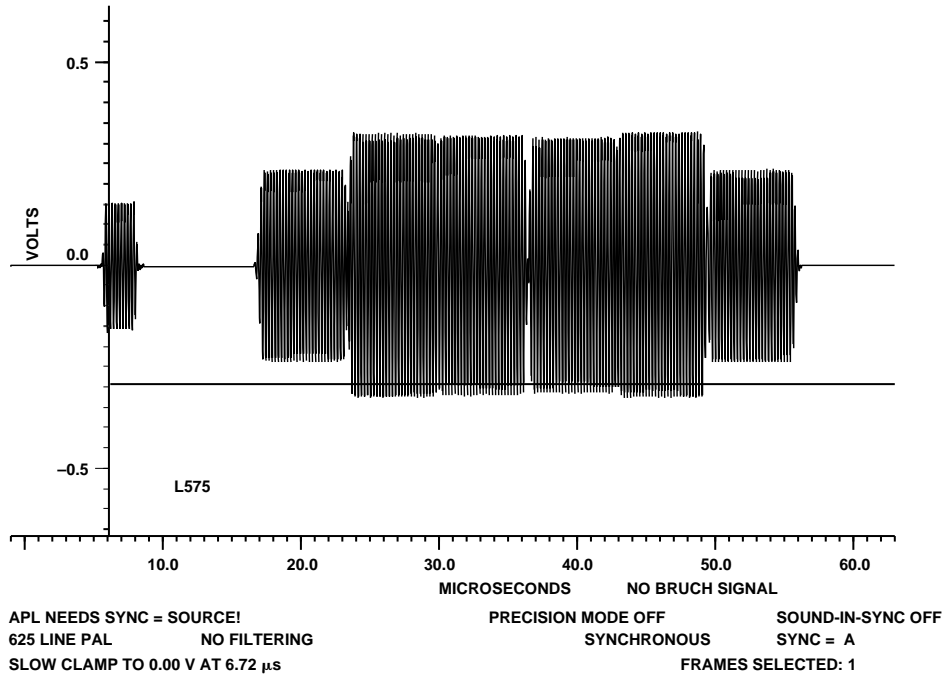

Figure 75. 100/75% PAL Color Bars Chrominance

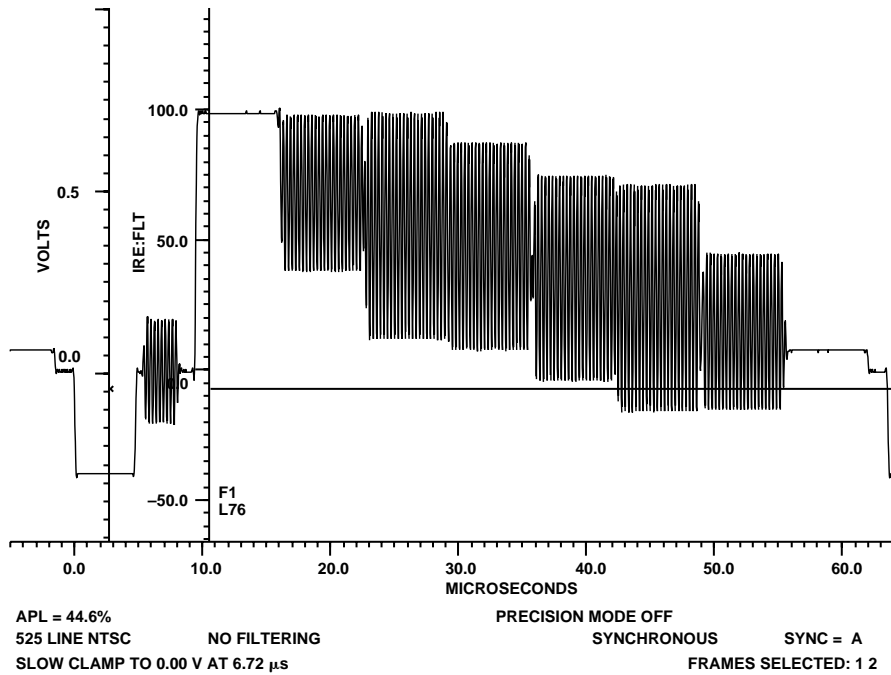

Figure 76. 100/75% NTSC Color Bars

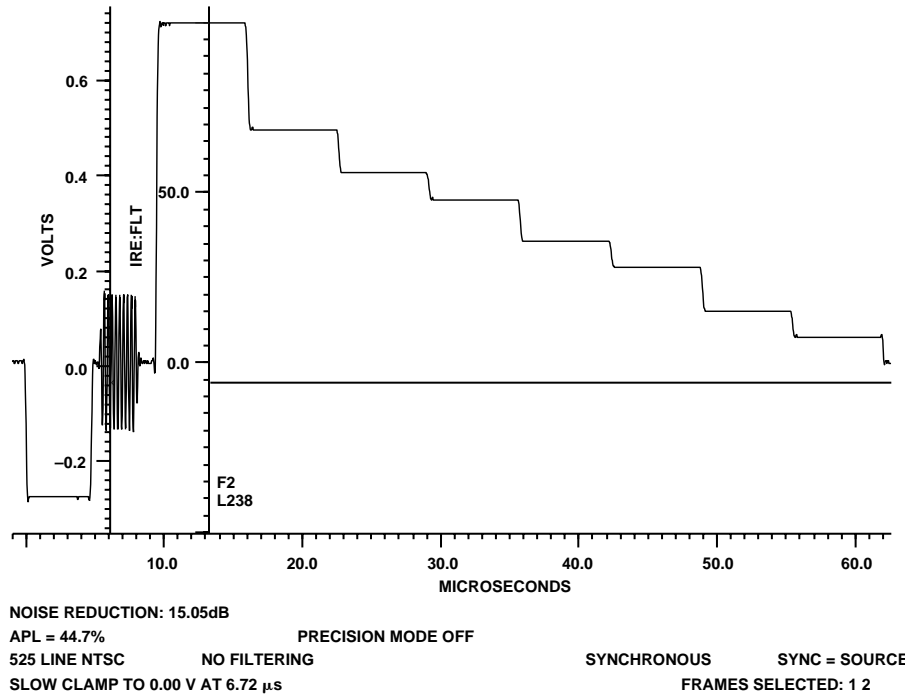

Figure 77. 100/75% NTSC Color Bars Chrominance

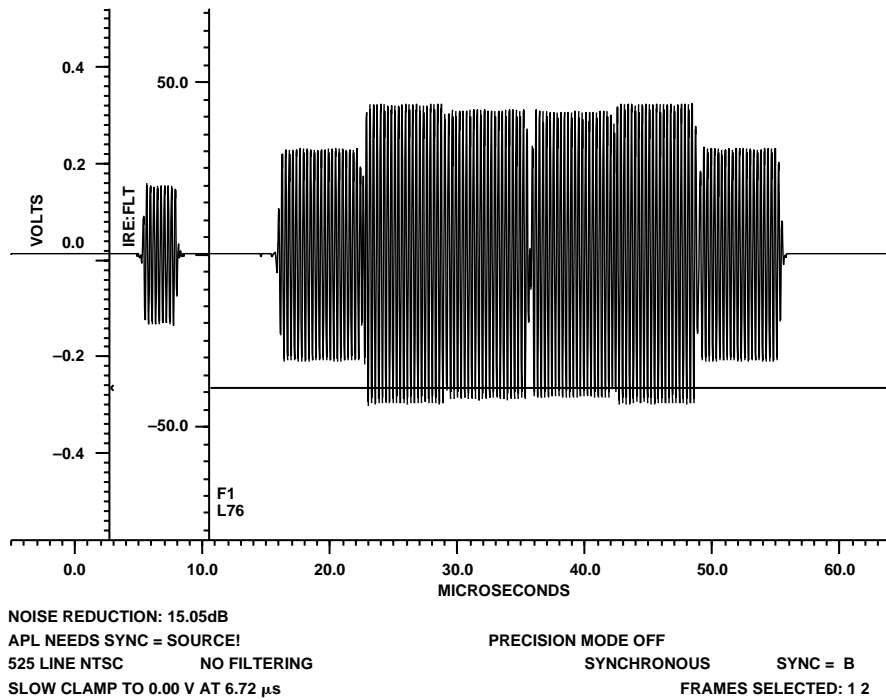

Figure 78. 100/75% NTSC Color Bars Chrominance

ADV7175A/ADV7176A

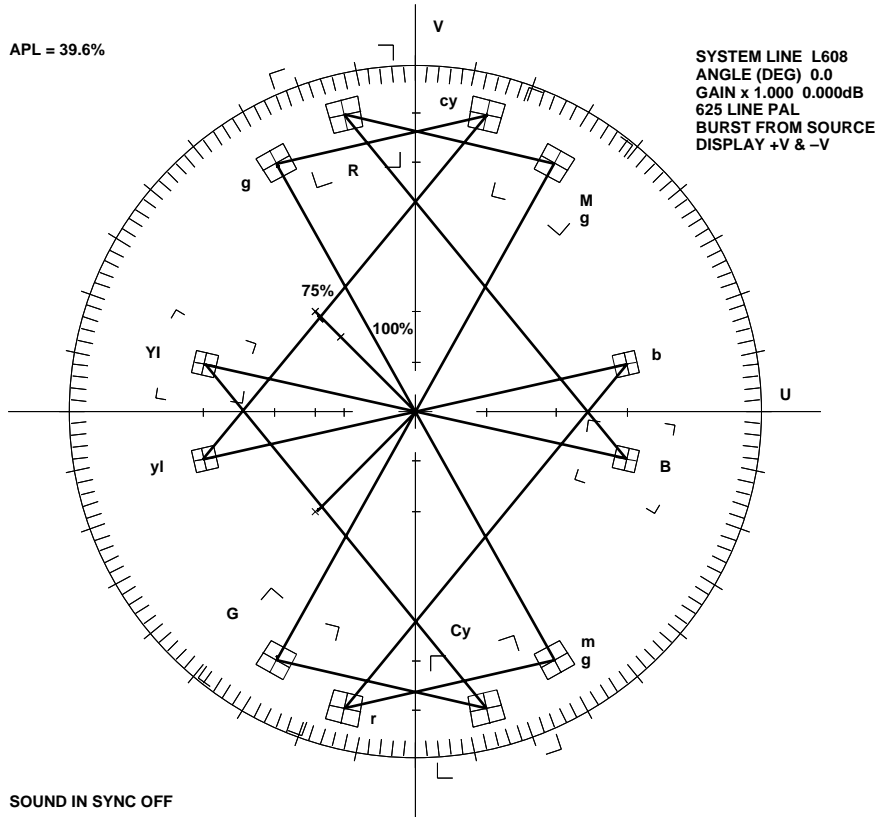

Figure 79. PAL Vector Plot

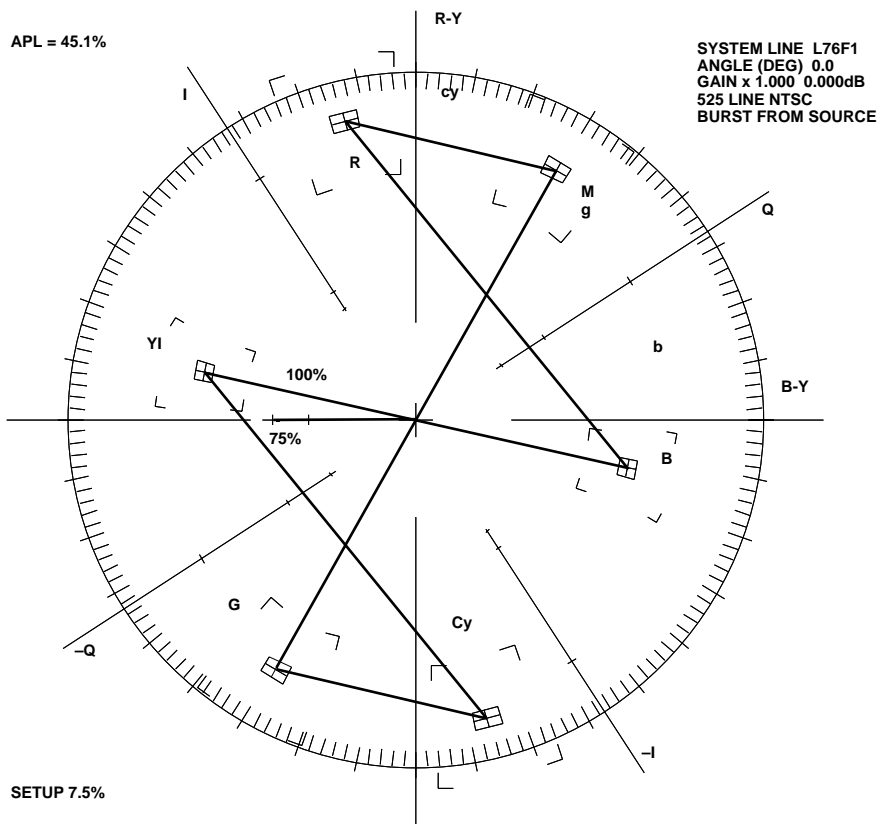

Figure 80. NTSC Vector Plot

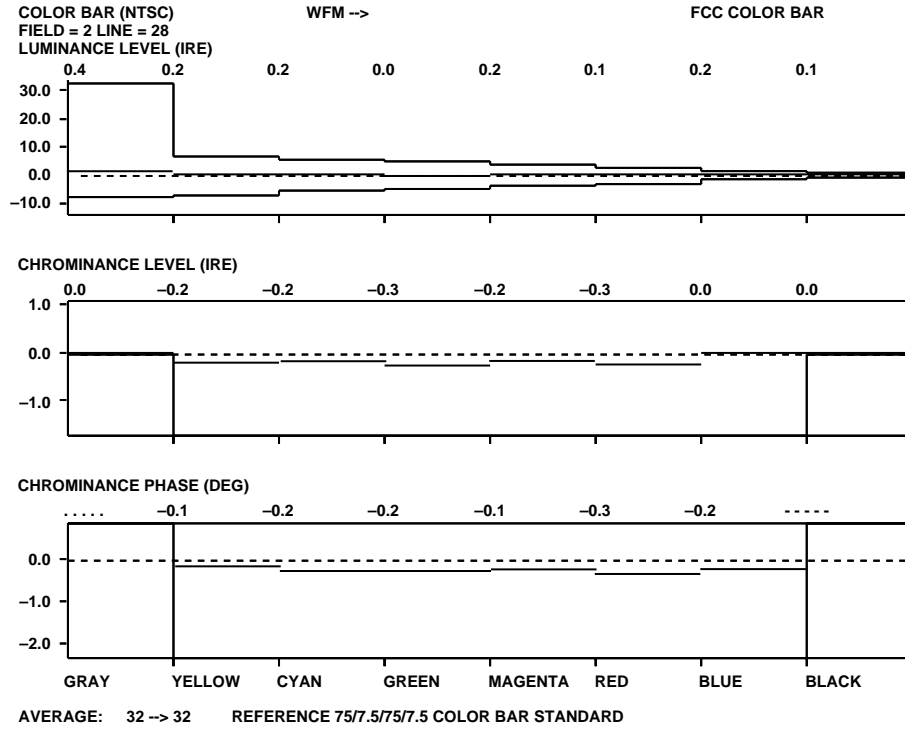

Figure 81. NTSC Color Bar Measurement

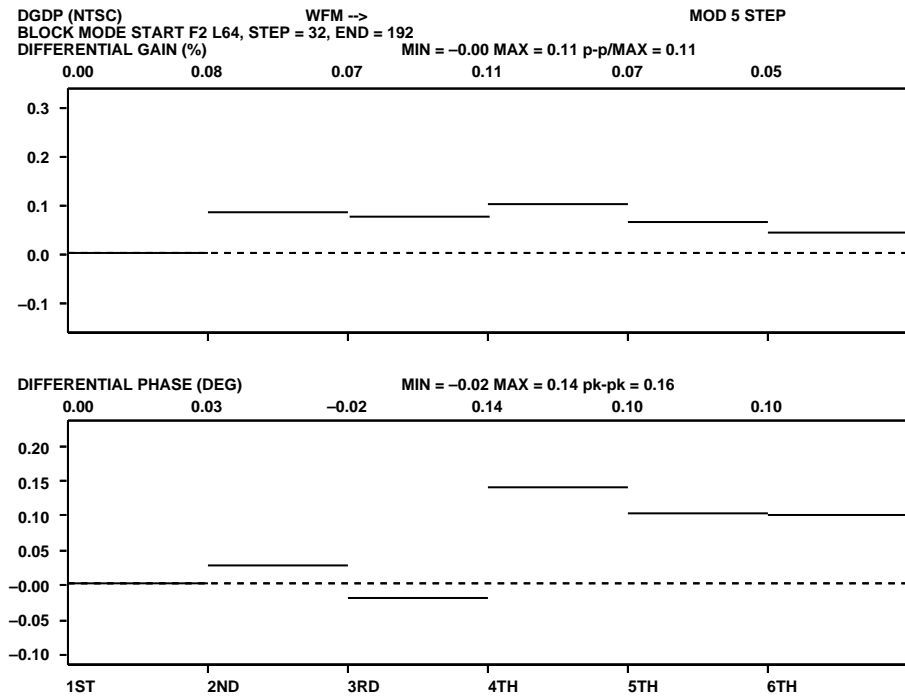

Figure 82. NTSC Differential Gain and Phase Measurement

ADV7175A/ADV7176A

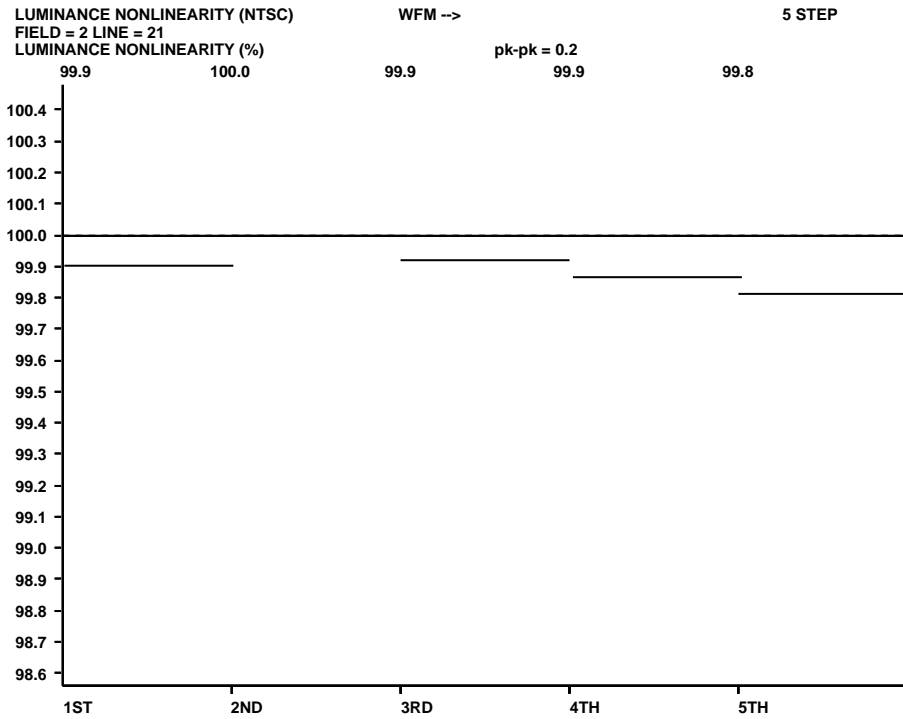

Figure 83. NTSC Luminance Nonlinearity Measurement

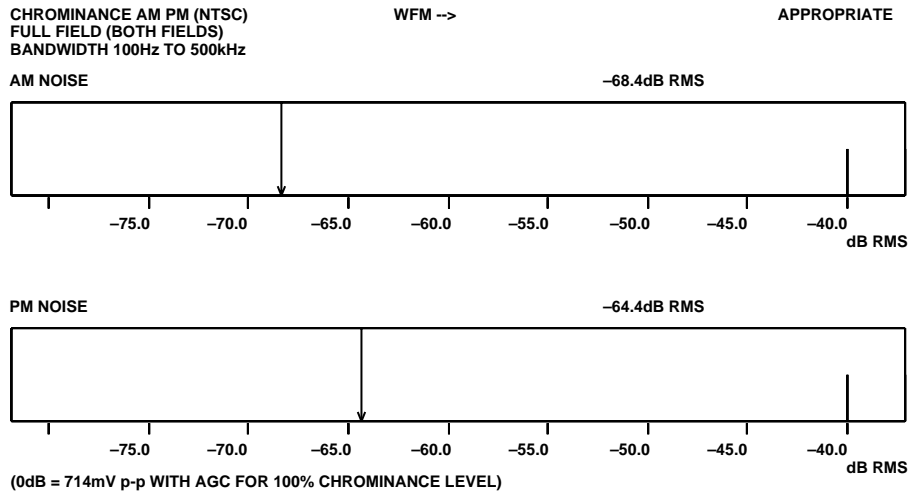

Figure 84. NTSC AMPM Noise Measurement

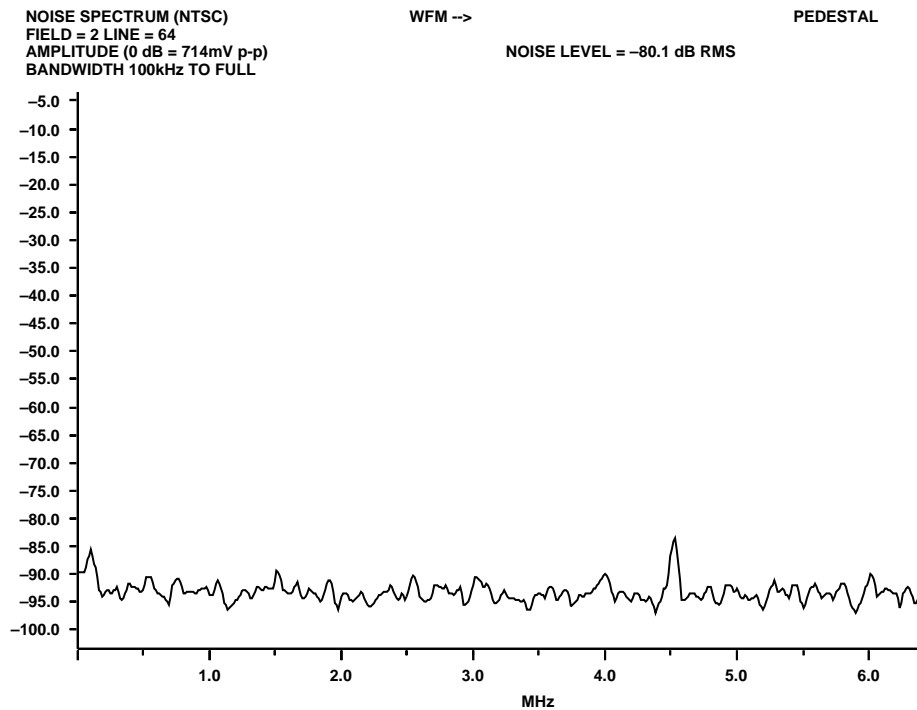

Figure 85. NTSC SNR Pedestal Measurement

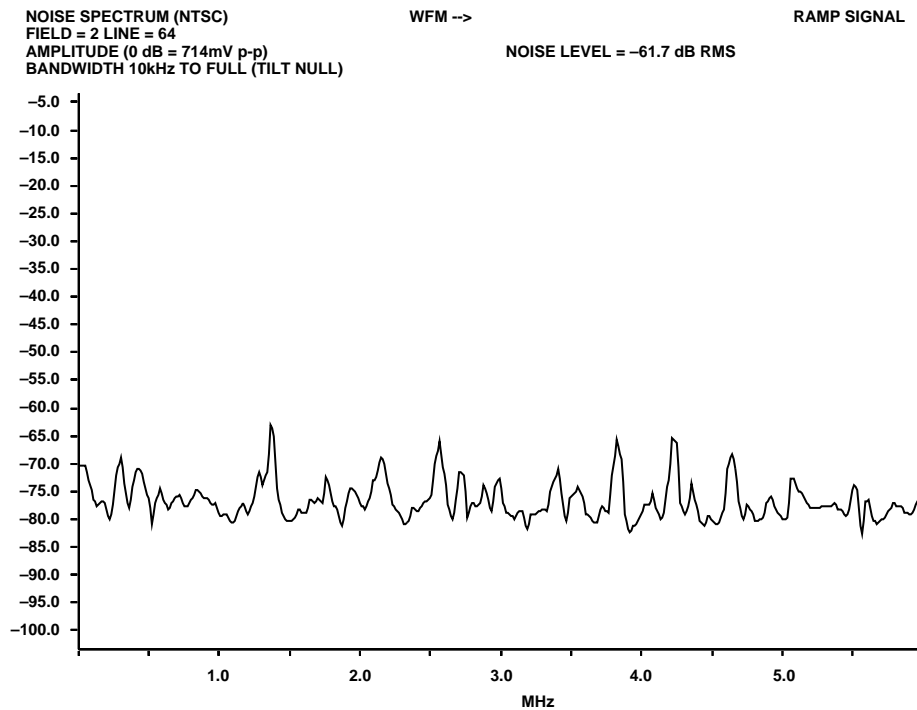

Figure 86. NTSC SNR Ramp Measurement

ADV7175A/ADV7176A

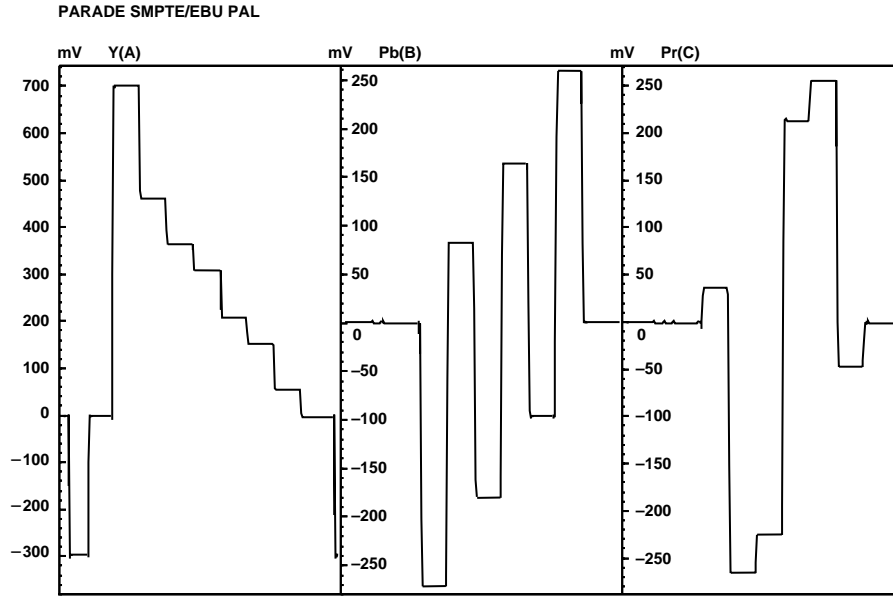

Figure 87. PAL YUV Parade Plot

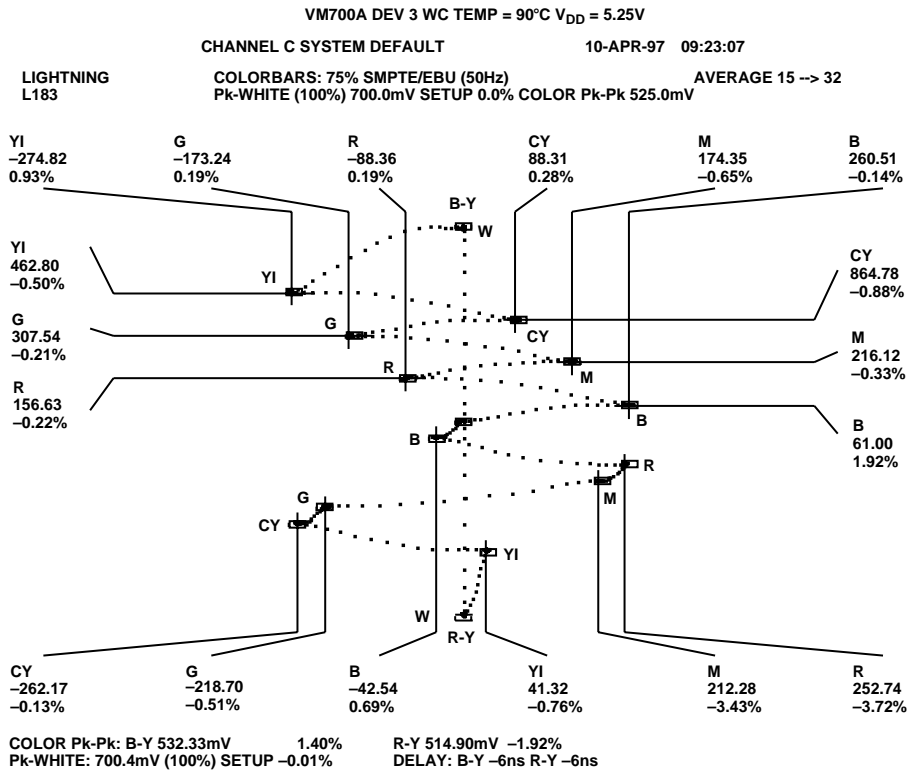

Figure 88. PAL YUV Lighting Plot

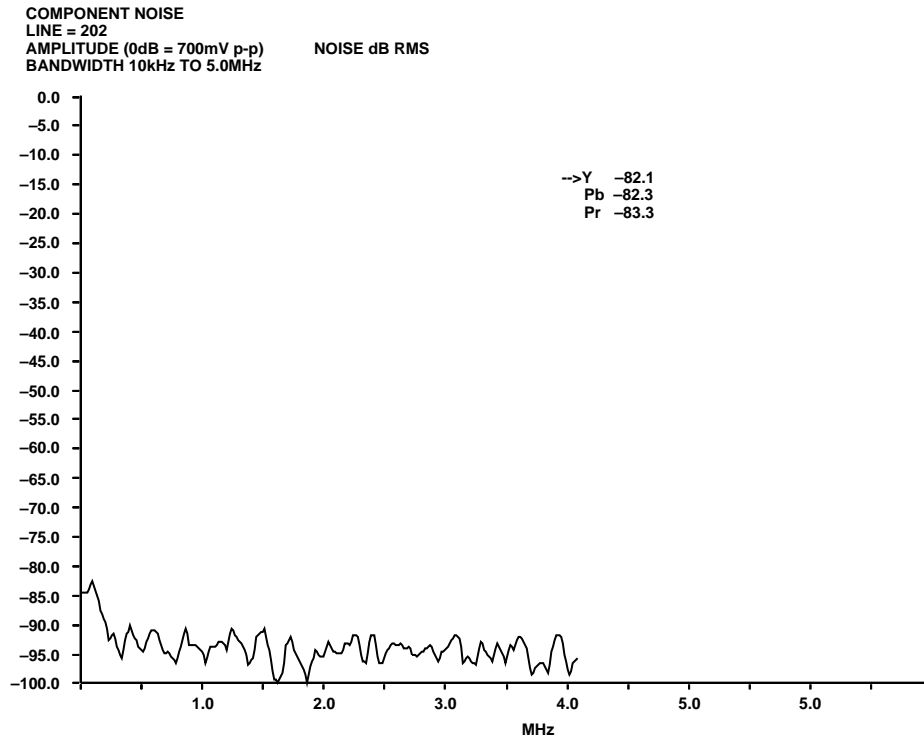

Figure 89. PAL YUV SNR Plot

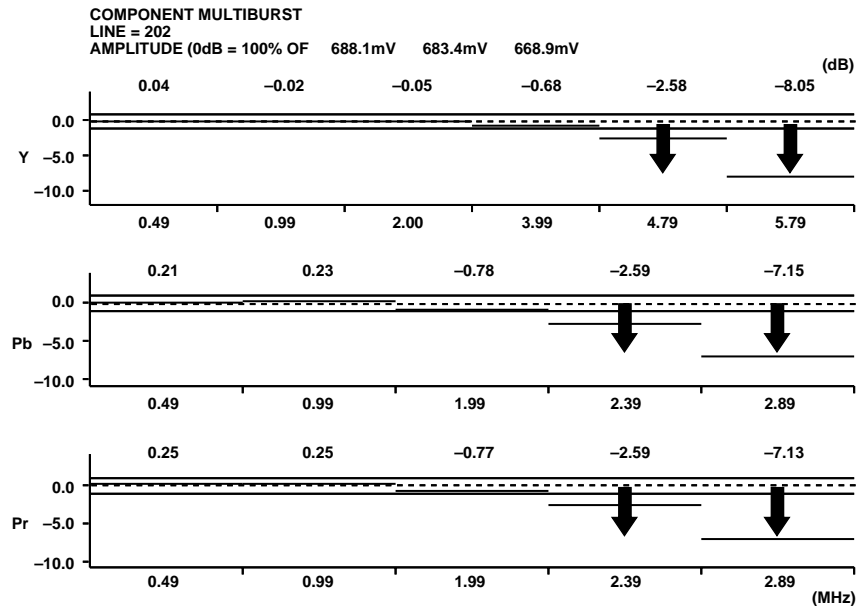

Figure 90. PAL YUV Multiburst Response

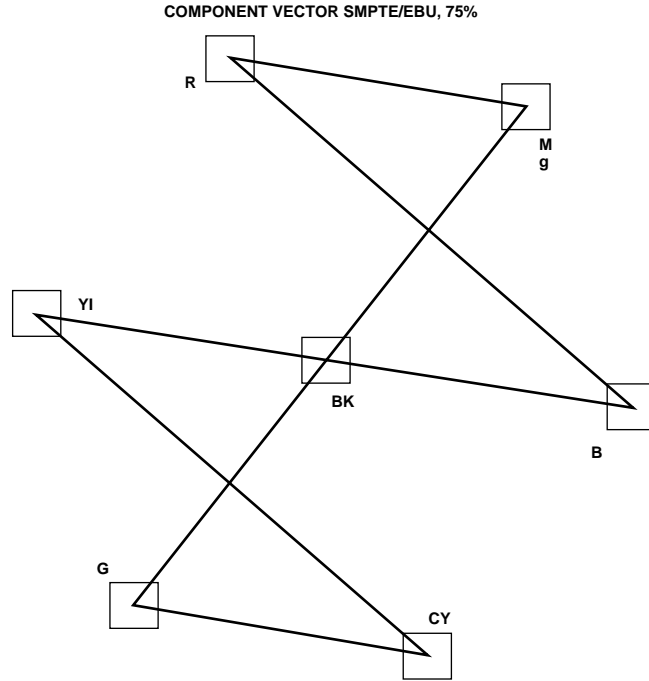

Figure 91. PAL YUV Vector Plot

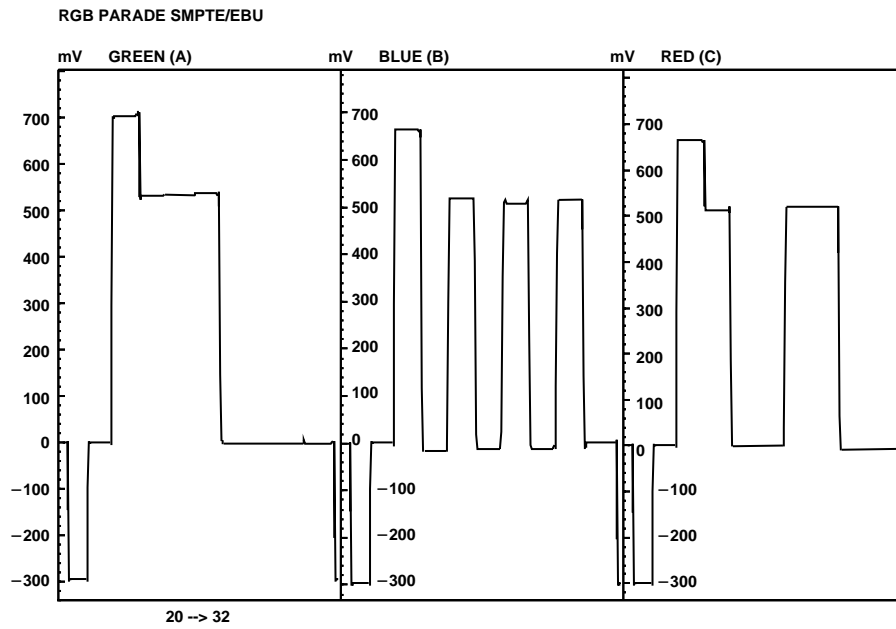

Figure 92. PAL RGB Waveforms

INDEX

| Contents | Page No. | Contents | Page No. |
|--|-----------------|--|-----------------|
| GENERAL DESCRIPTION | 1 | MODE REGISTER 1 | 24 |
| ADV7175A/ADV7176A SPECIFICATIONS | 2 | MR1 BIT DESCRIPTION | 24 |
| TIMING SPECIFICATIONS | 6 | SUBCARRIER FREQUENCY REGISTER | 24 |
| ABSOLUTE MAXIMUM RATINGS | 9 | SUBCARRIER PHASE REGISTER | 24 |
| ORDERING GUIDE | 9 | TIMING REGISTER 0 | 24 |
| PIN CONFIGURATION | 9 | TR0 BIT DESCRIPTION | 24 |
| PIN FUNCTION DESCRIPTIONS | 10 | CLOSED CAPTIONING EVEN FIELD | 25 |
| DATA PATH DESCRIPTION | 11 | CLOSED CAPTIONING ODD FIELD | 25 |
| INTERNAL FILTER RESPONSE | 11 | TIMING REGISTER 1 | 25 |
| COLOR BAR GENERATION | 13 | TR1 BIT DESCRIPTION | 25 |
| SQUARE PIXEL MODE | 13 | MODE REGISTER 2 | 25 |
| COLOR SIGNAL CONTROL | 13 | MR2 BIT DESCRIPTION | 25 |
| BURST SIGNAL CONTROL | 13 | NTSC PEDESTAL/PAL TELETEXT CONTROL | |
| NTSC PEDESTAL CONTROL | 13 | REGISTERS 3-0 | 26 |
| PIXEL TIMING DESCRIPTION | 13 | MODE REGISTER 3 | 26 |
| SUBCARRIER RESET | 13 | MR3 BIT DESCRIPTION | 26 |
| REAL TIME CONTROL | 13 | TELETEXT CONTROL REGISTER TC07 | 27 |
| VIDEO TIMING DESCRIPTION | 13 | APPENDIX 1. BOARD DESIGN AND LAYOUT | |
| Timing Mode 0 | 14 | CONSIDERATIONS | 28 |
| Timing Mode 1 | 16 | APPENDIX 2. CLOSED CAPTIONING | 30 |
| Timing Mode 2 | 18 | APPENDIX 3. TELETEXT INSERTION | 31 |
| Timing Mode 3 | 20 | APPENDIX 4. WAVEFORMS | 32 |
| OUTPUT VIDEO TIMING | 21 | APPENDIX 5. REGISTER VALUES | 36 |
| POWER-ON RESET | 21 | APPENDIX 6. OPTIONAL OUTPUT FILTER | 37 |
| MPU PORT DESCRIPTION | 21 | APPENDIX 7. OPTIONAL DAC BUFFERING | 38 |
| REGISTER ACCESSES | 23 | APPENDIX 8. OUTPUT WAVEFORMS | 39 |
| REGISTER PROGRAMMING | 23 | OUTLINE DIMENSIONS | 50 |
| MODE REGISTER 0 | 23 | | |
| MR0 BIT DESCRIPTION | 23 | | |

OUTLINE DIMENSIONS

Dimensions shown in inches and (mm).

**Plastic Quad Flatpack
(S-44)**

